

The Islamic University–Gaza  
Research and Postgraduate Affairs  
Faculty of Engineering  
Master of Control system



الجامعة الإسلامية - غزة  
شئون البحث العلمي والدراسات العليا  
كلية الهندسة  
ماجستير أنظمة تحكم

## Management of Distributed Power Generation Sources: Case Study - KAMAL EDWAN Hospital

إدارة مصادر توليد الطاقة الموزعة بمستشفى كمال عدوان  
كدراسة حالة

Mohammed O. Alshair

Supervised by

Dr. Hatem ELaydi

A thesis submitted in partial fulfillment  
of the requirements for the degree of  
Master of Science in Electrical Engineering

June/2016

إقرار

أنا الموقع أدناه مقدم الرسالة التي تحمل العنوان:

## **Management of Distributed Power Generation Sources: Case Study - KAMAL EDWAN Hospital**

إدارة مصادر توليد الطاقة الموزعة بمستشفى كمال عدوان كدراسة حالة

أقر بأن ما اشتملت عليه هذه الرسالة إنما هو نتاج جهدي الخاص، باستثناء ما تمت الإشارة إليه حيثما ورد، وأن هذه الرسالة ككل أو أي جزء منها لم يقدم من قبل الآخرين لنيل درجة أو لقب علمي أو بحثي لدى أي مؤسسة تعليمية أو بحثية أخرى.

### **Declaration**

I understand the nature of plagiarism, and I am aware of the University's policy on this.

The work provided in this thesis, unless otherwise referenced, is the researcher's own work, and has not been submitted by others elsewhere for any other degree or qualification.

Student's name: محمد عمر الشاعر اسم الطالب:

Signature: . التوقيع:

Date: 7/5/2016 التاريخ:



## Abstract

The availability and continuity of electrical power sources in sensitive building like hospitals is very important issue. Due to the unstable power grid conditions in Gaza Strip, inefficient amount from the main electrical power supplied by public grid, and risk of electrical power fault occurring daily, sensitive building are provided with extra alternative supplies (Diesel Engine Generators). This thesis will propose a design (solution) for main traditional electrical distribution boards and automatic and manual transfer switch (ATS & MTS) to ensure availability and flexibility of electrical power supply for all loads in hospitals under all circumstances. This thesis will also propose a control mechanism which contributes in reducing fuel consumption used by power generators by measuring power consumption and transferring loads to suitable size generator to avoid high loading (may damage the generator) or low loading (high fuel consumption related with power produced) on generators. In this thesis we use KAMAL EDWAN hospital's electrical power system as a case study. The results are obtained by applying the proposed control approach using programmable logic controller, PLC unit, to ensure generator loading within 40% to 85% of its rated capacity under special circumstances that leads to the best efficiency fuel consumption.

**Keywords:** PLC, ATS, MTS, Fuel Consumption .

## Abstract In Arabic

### المخلص

توفر واستمرارية مصادر الطاقة الكهربائية في المنشآت الحساسة مثل المستشفيات تعتبر من القضايا المهمة. نظرا للظروف غير المستقرة لشبكة الكهرباء العامة في قطاع غزة، وعدم كفاءة مقدار الطاقة الكهربائية الرئيسية التي توفرها الشبكة العامة ، فان خطر فقدان الطاقة الكهربائية من الشبكة يحدث بشكل يومي. لذا المؤسسات الحساسة مثل المستشفيات ومراكز البيانات تزود عادة بمصادر تغذية بديلة (مولدات كهربائية). هذه الأطروحة تقدم تصميم (حل) للوحات التوزيع الكهربائية التقليدية الرئيسية ولوحات التحويل اليدوي والآلي لضمان توفر والمرونة في إمدادات الطاقة الكهربائية لجميع الأحمال في المستشفيات في جميع الظروف. أيضا هذه الأطروحة تقدم آلية تحكم تساهم في عملية تقليل من استهلاك السولار من قبل المولدات بواسطة مراقبة استهلاك المستشفى من الطاقة الكهربائية و نقل الأحمال على المولد المناسب للحمل الذي يحتاجه المستشفى بحيث نتجنب التحميل العالي (والذي قد يضرر المولد) و نتجنب التحميل المنخفض (الذي يسبب في عدم كفاءة في استهلاك السولار بالنسبة للطاقة المنتجة ) على المولدات . في هذه الرسالة سوف نناقش مشكلة موجودة في نظام الطاقة الكهربائية بمستشفى كمال عدوان كحالة للدراسة . في النتائج التي حصلنا عليها بعد تطبيق نظام التحكم المقترح بواسطة استخدام متحكم قابل للبرمجة PLC في تشغيل المولدات بناءا على الحمل الذي يحتاجه المستشفى و جدنا إن الحمل على المولدات سوف يكون بين ٤٠ % إلى ٨٥ % والذي يجعل المولدات تعمل في أعلى كفاءة في عملية التقليل من استهلاك السولار .

**كلمات افتتاحية :** استهلاك السولار ، التحويل الآلي ، التحويل اليدوي ،متحكم قابل للبرمجة.

## **Dedication**

*To the soul of my mother and grandmother , where they always hope to be succeed, I feel they are always with me supporting and guiding.*

*To my beloved father , for his constant prayers, his support, encouragement, and constant love have sustained me throughout my life, and for his confidence in me.*

*To my Wife, for her relentless care and support. Her understanding have lightened up my spirit to finish this thesis.*

*To my Children, Rafeef , Omar ,and Dima with hope for a bright future.*

## **Acknowledgment**

I address my sincere gratitude to Allah as whenever I faced any problem I used to pray to God to help me and He always was there protecting and saving me. Then, I would like to express my deep gratitude to my advisor Dr.Hatem Elaydi , who spared much time in supporting me with all concern.

I would like to thank everyone who has directly or indirectly helped me during the course of this work. Last but not least, I would love to thank my family for their support and care, especially my father. May Allah bless and protect them all.

## Table of Contents

Declaration .....	ii
Abstract .....	iv
Abstract In Arabic .....	v
Dedication .....	vi
Acknowledgment .....	vii
Table of Contents .....	viii
List of Tables .....	x
List of Figures .....	xi
List of Appreviation .....	xiI
<b>Chapter 1 Introduction</b> .....	1
1.1 Overview : .....	1
1.2 Statement of Problem:.....	2
1.3 Load Analysis and Analysis of current status: .....	4
1.4 Previous Study: .....	9
1.5 Thesis Objectives: .....	12
1.6 The Motivation:.....	12
1.7 The Contribution: .....	12
1.8 The Methodology :.....	13
1.9 Thesis Organization: .....	13
<b>Chapter 2 Background</b> .....	14
2.1 Introduction: .....	14
2.2 Generator Efficiency:.....	14
2.3 Impact of Low Load Operations: .....	14
2.4 Generator Optimization:.....	16
2.5 Load priority panel:.....	17
2.6 Load Curve:.....	17
2.7 Important definitions:.....	18
<b>Chapter 3 Proposed Electrical Power System Structure</b> .....	21
3.1 Modification in generators Size: .....	21
3.2 Modification in Main Electrical Distribution Board : .....	21



3.3 System Components Descriptions: .....	23
3.3.1 Manual Transfer Switch (MTS):.....	23
3.3.2 Automatic Transfer Switch (ATS):.....	24
3.3.3 Generators: .....	26
3.3.4 Control Unit : .....	26
<b>Chapter 4 Control, Simulation and Results.....</b>	<b>29</b>
4.1 Controlling and running generators in emergency situations: .....	29
4.2 Controlling, running and transforming power depending on Load demands: .....	30
4.3 Control process in switching of ATSS: .....	34
4.4 Simulation and Results: .....	35
<b>Chapter 5 Conclusions.....</b>	<b>41</b>
<b>References.....</b>	<b>42</b>
<b>Appendix A PLC Wiring Diagram.....</b>	<b>44</b>
<b>Appendix B PLC Ladder Program .....</b>	<b>47</b>

## List of Tables

<b>Table(1.1):</b> Hospital consumption of main electricity, generators running hours ,and diesel consumption during 2015 year.	4
<b>Table(1.2):</b> fuel consumption for each of generator at various loads.	5
<b>Table(1.3):</b> Hospital NEL, EL ,and VIL loads.	7
<b>Table (2.1):</b> Fuel Consumption versus load chart ("Guide to Best Energy" 2011).	15
<b>Table (2.2):</b> Load levels in percentage of maximum continuous rating	15
<b>Table (3.1):</b> PLC's inputs and outputs signals Addresses and Description	27
<b>Table (4.1):</b> Average Current ( AVGC ) produced by 300KVA,400KVA ,and 500 KVA generator at 40%,60%,80%,85% of their capacity	32

## List of Figures

<b>Figure(1.1):</b> Total hospital loads curve at summer, autumn, winter, and spring.....	6
<b>Figure (1.2) :</b> Single line diagram for ATS's, MTS's, and Main Electrical Distribution Boards In KAMAL EDWAN Hospital. ....	6
<b>Figure (2.1):</b> Daily load curve of a certain power system. ....	17
<b>Figure (2.2) :</b> Daily load curve respect to range of demand. ....	18
<b>Figure (3.1):</b> 300 KVA generator supplying VIL loads only .....	22
<b>Figure (3.2):</b> Suggested electrical power distribution board .....	22
<b>Figure (3.3):</b> MTS single line diagram .....	23
<b>Figure(3.4):</b> Indoor and Outdoor of MTS board in electrical distribution board .....	23
<b>Figure (3.5) :</b> Control Diagram for ATS .....	24
<b>Figure(3.6) :</b> Indoor of ATS board in electrical distribution board.....	25
<b>Figure (3.7) :</b> FG Wilson generator control Panel .....	26
<b>Figure (4.1):</b> Flow chart for selecting operating generators in emergency situations .....	30
<b>Figure (4.2):</b> Flow chart for selecting generator size depending on load demands..	33
<b>Figure (4.3):</b> Flow chart for switching in ATSS .....	34
<b>Figure (4.4):</b> Simulation graphic user interface for testing suggested control system. ....	35
<b>Figure (4.5):</b> a) Hospital load curve in August for one day and, b) time period of running generators in old system. ....	36
<b>Figure (4.6):</b> a) Hospital load curve in August for one day and, b) time period of running generators in suggested control system. ....	37
<b>Figure (4.7):</b> a) Hospital load curve in April for one day and, b) time period of running generators in old system .....	38
<b>Figure (4.8):</b> a) Hospital load curve in April for one day and, b) time period of running generators in suggested control system. ....	38
<b>Figure (4.9) :</b> a) Hospital load curve in September for one day and, b) time period of running generators in old system. ....	39
<b>Figure (4.10):</b> a) Hospital load curve in September for one day and, b) time period of running generators in suggested control system. ....	39

## List of Abbreviations

<b>ATS</b>	Automatic Transfer Switch.
<b>AVGC</b>	Average Current.
<b>CT</b>	Current Transformer.
<b>DiF</b>	Diversity Factor .
<b>DF</b>	Demand Factor.
<b>EL</b>	Essential Loads .
<b>ICU</b>	Intensive Care Unit .
<b>LF</b>	Load Factor.
<b>MD</b>	Maximum Demand.
<b>MTS</b>	Manual Transfer Switch .
<b>MCCB</b>	Modeled Case Circuit Breaker.
<b>NEL</b>	Non-Essential Loads.
<b>PLC</b>	Programming Logic Controller.
<b>PCF</b>	Plant Capacity Factor.
<b>UPS</b>	Uninterruptible Power Supplies.
<b>VIL</b>	Very Important Loads.

# Chapter 1

## Introduction

### 1.1 Overview :

Electricity is one of the important issues in our life. There are many businesses, institutions, and industrials that their works depend on continuously supplied electricity without interruption. Institutions like hospitals, the interruption in electricity will lead to dangerous situations like death of some patients. Because there is a high possibility of electrical interruption in Gaza Strip, hospitals must be fitted with alternate electrical sources like generators.

In Gaza Strip, the public main electrical grid consists of 207 MW (120 MW from Israel Electrical grid, 22 MW Egypt Electrical grid, and 65 MW from Gaza Power Generation Station in ALNOSYRAT) but Gaza Strip load demands of electrical power varies between 450 MW (in winter and summer) and 350 MW (in spring and autumn) that means the inability to cover the demand of electrical power reach up to 40 % (Palestinian Energy and Natural Resources Authority PENRA,2015). Due to the inefficient electrical power obtained from the main source, the risk of main electrical fault occurs daily.

Hospitals get electricity from the public electricity grid, due to the sensitivity and importance of hospitals, they are provided with alternative electricity lines from main electricity grid, also provided by small and medium power generators and uninterruptible power supplies (UPS's), which work as alternative power supply at interruption of main electrical source. International Standards requires the existence of electrical generators and UPSs inside hospital for emergency situations like interruption of main electrical supply. Electrical interruptions result of many reasons such as loss of transformer, transmission lines, circuit breakers, or distribution boards. Hospitals electrical loads can be usually divided into three parts : Non-Essential Loads (NEL), Essential Loads (EL), and Very Important Loads (VIL). In case of normal electricity supplies from the main local grid, all parts of hospital will

be supplied from the main supply source. When fault in public electrical grid, standby electrical generators will be switched ON and the EL and VIL will be supplied with the required electricity. When fault occurs to the standby generator, the emergency generator will be switched ON and the VIL will be supplied with the necessary electricity.

Electrical Generators vary in size and vary in electrical power output capacity; thus, they vary in fuel consumption, so large engine generators consume more fuel than smaller one at the same loading conditions.

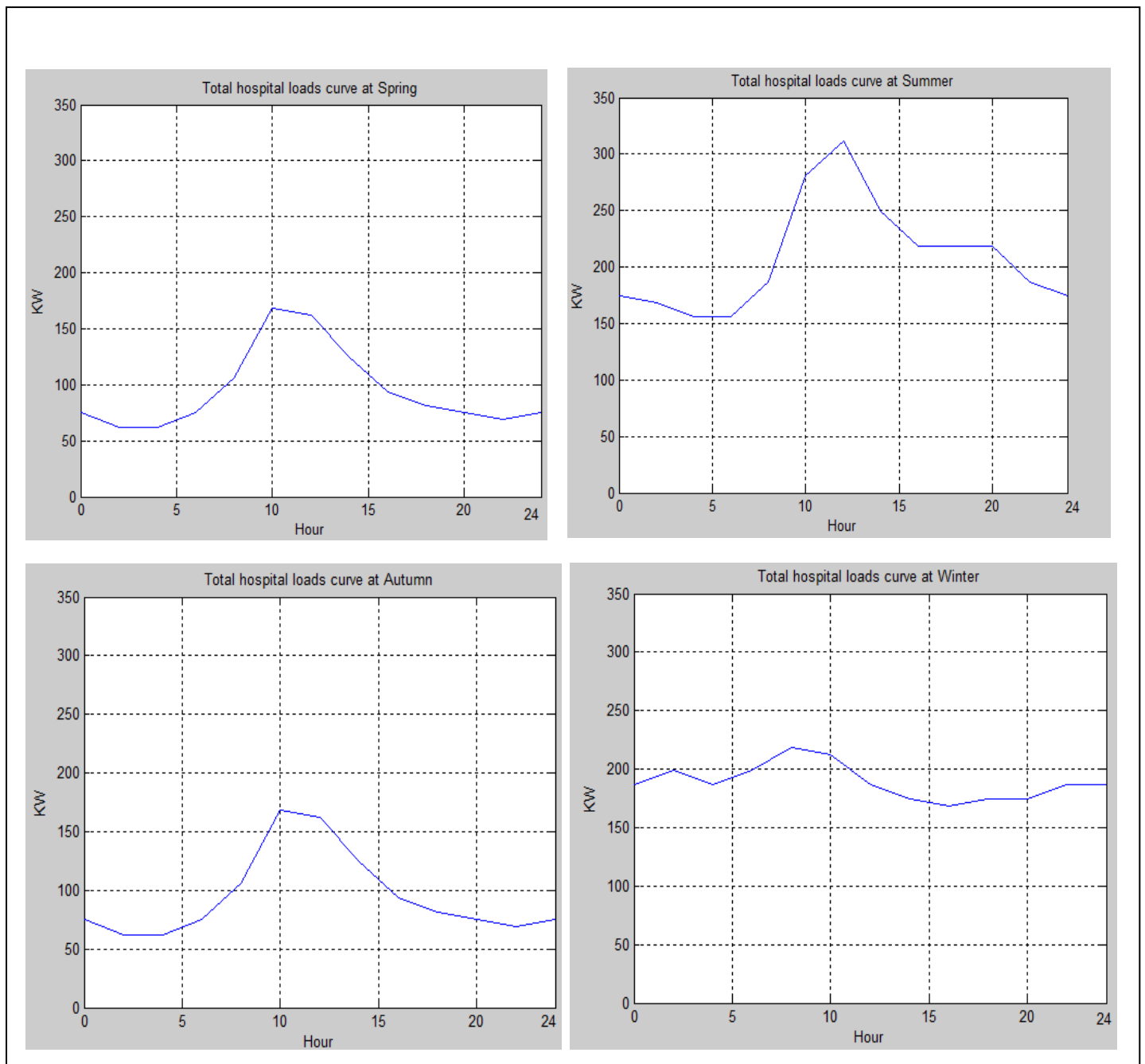
In Gaza Strip, there are unstable living conditions specially when we are talking about availability of fuel needed for electrical generator. Due to the size of hospitals electrical generator units, they consume large amount of fuel. The loads at different times of the year do not require large amounts of energy, so in other words smaller size generator and less consumption can meet the needs of hospitals loads.

In this thesis, we propose a methodology to design electrical distribution boards, and design configuration procedures in running and switching electrical generators that ensures the continuity of electrical to all parts of hospital loads, and to ensure low fuel generators consumption at every situations.

## **1.2 Statement of Problem:**

Electrical load demands in hospitals vary all over the year. During summer and winter, the loads demands are higher than loads demands during the spring and autumn. Thus, the high-capacity dedicated generator is suitable for loads during summer and winter periods but not suitable for spring and autumn. Moreover, it is even not suitable during summer and winter at evenings and night periods due to the large amount of fuel consumption, while the same loads at those intervals (low demand periods) can be covered by smaller size generator with low fuel consumption. This problem is noticed clearly at Kamal Edwan hospital as we see in figure(1.1) (Maintinnce Department in Kamal Edwan Hospital,2015). After reviewing the available official documentation of hospital electrical power consumption from

public main electrical distribution network, generators running hours, and the amount of diesel consumed by generators, we summarized all the information in table (1.1) for future study and analysis in order to reduce diesel consumption and avoiding or running generator in low load case (Maintinnce Department in Kamal Edwan Hospital,2015), and (Gaza Electricity Distribution Corporation GEDECO, 2015).



**Figure(1.1):** Total hospital loads curve at summer, autumn, winter, and spring.

**Table(1.1):** Hospital consumption of main electricity, generators running hours ,and diesel consumption during 2015 year (Kamal Edwan Hospital - Maintenance Department in, 2015).

Month	KWHs consumed from Main	Main Source Hrs.	400KVA Running Hrs.	700KVA Running Hrs.	Diesel liters Cons. per month
1/2015	43468	352	392	0	15100
2/2015	45260	364	308	0	10700
3/2015	45532	308	436	0	13980
4/2015	32108	393	327	0	10300
5/2015	66888	454	292	0	9350
6/2015	49432	390	330	0	11600
7/2015	64300	331	393	20	15480
8/2015	39384	302	412	30	18950
9+10/2015	126000	795	644	25	28550
11/2015	54820	403	317	0	13800

### 1.3 Load Analysis and Analysis of current status:

Table(1.1) shows no indication about 300 KVA generator because it cannot supplies all hospital loads if we use it as main source. Thus, the 300 KVA generator running hours are not important to be included in this table. The 300 KVA generator rarely run to preside supply to the hospital because it run only if all main sources have been failed.

Kamal Edwan hospital has three electrical engine generators: Cummins 700 KVA, Perkins 400 KVA, and Perkins 300 KVA. Table(1.2) shows three generators with fuel consumption at varies percentage of loading for each generator .



**Table(1.2):** Fuel consumption for each of generator at various loads (Cummins Power Generation, 2007),( FG Wilson,2014).

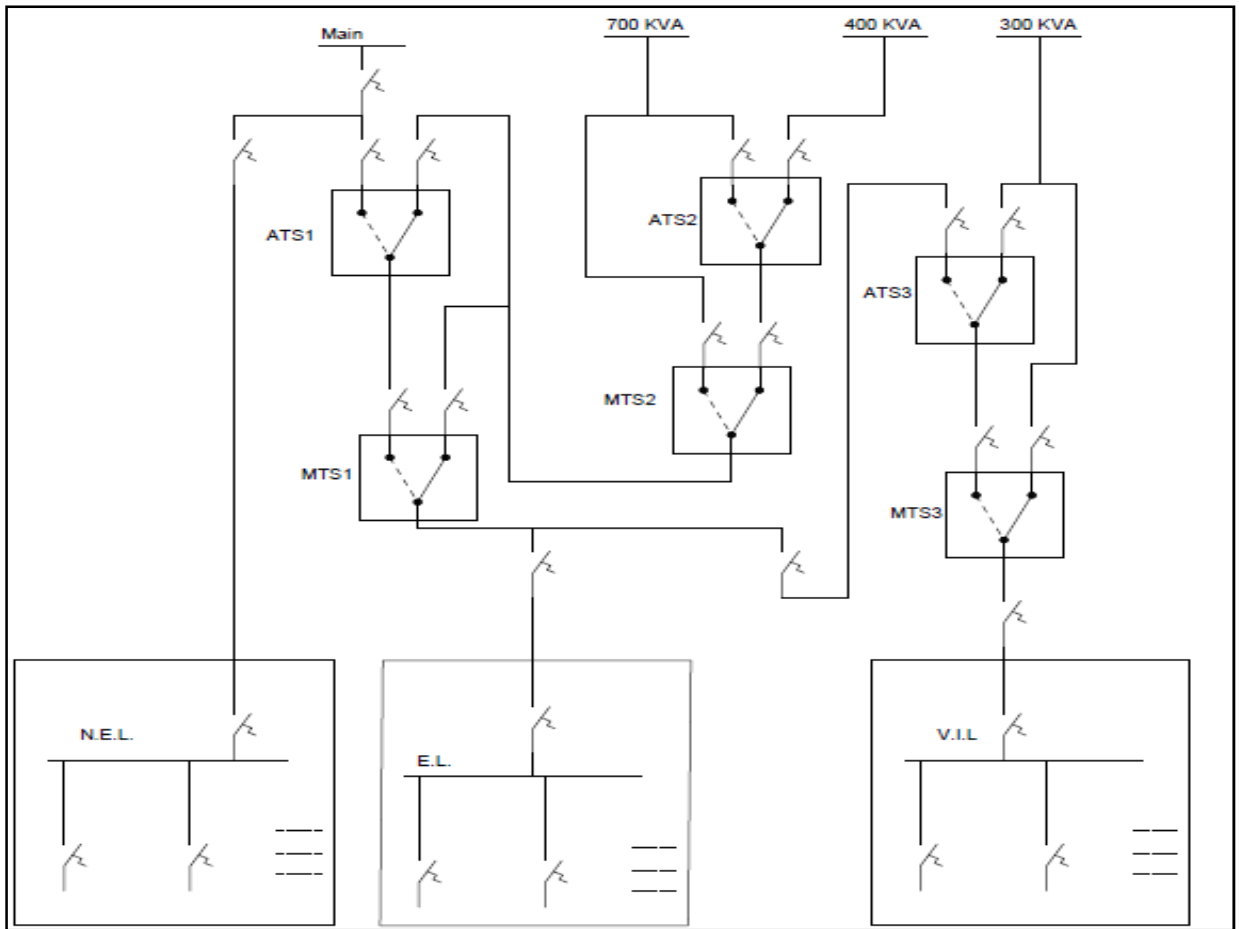
<b>Cummins 700 KVA</b>			<b>Perkins 400 KVA</b>			<b>Perkins 300 KVA</b>		
<b>Prime(640KVA/512KW)</b>			<b>Prime(350KVA/280KW)</b>			<b>Prime(275KVA/220KW)</b>		
<b>Load</b>	<b>Fuel Consumption (l/hr)</b>	<b>Output KWh\L</b>	<b>Load</b>	<b>Fuel Consumption (l/hr)</b>	<b>Output KWh\L</b>	<b>Load</b>	<b>Fuel Consumption (l/hr)</b>	<b>Output KWh\L</b>
25%	43	2.9	25%	26	2.9	25%	20	2.87
50%	73	3.5	50%	36.2	3.8	50%	31.2	3.5
75%	104	3.7	75%	53	3.9	75%	43.3	3.8
100%	140	3.65	100%	69.6	4	100%	55.5	3.96

From table(1.2), as the loading on generator increases then the number of KW produced for each liter diesel consumed will increase that leads to best fuel consumption efficiency when generators run at 75% of loading. If loading on generator is under 50% of loading, it leads to less fuel consumption efficiency.

After reviewing hospital load curve, we found hospital loads rarely exceeding 250 KW (excepting peak time at summer) that means if the 700 KVA generator run, it will run at extremely low loading so it is not suitable for hospital electrical power system. When the Main electrical line fails, the standby generator (Cummins 700 KVA or Perkins 400 KVA) will run to supply the essential loads and very important loads. If the two standby generators fail, the emergency 300 KVA generator run to supply only the very Important loads (like operations and Intensive care unit departments).

As noticed, there is no proper management in selecting and running generators to supply hospital with electrical power. Also the designing of electrical distribution

boards and changeover switches are not efficient to ensure electrical continuity for all hospital loads at emergency situations. For example; sometimes, the 400 KVA generator is switched ON to supply EL instead of selecting the 300 KVA generator as seen in figure(1.2). Another problems we faced that there is no automatic changeover when electrical loads exceed the capacity of generators that may damage the generator or reduce generator lifecycle.



**Figure (1.2):** Single line diagram for ATS's, MTS's, and Main Electrical Distribution Boards In KAMAL EDWAN Hospital.

Figure (1.2) shows the loads in KAMAL EDWAN hospital divided into three partitions: 1-non-essential loads (NEL) like non-essential air condition loads, 2-essential loads (EL) like Oxygen generator station, and Very Important Loads (VIL) like operations rooms table(2.3) shows hospital NEL, EL ,and VIL loads.

**Table(1.3):** Hospital NEL, EL ,and VIL loads.

NEL	EL	VIL
Hospital Corridors Air Conditions	Oxygen Generator Station	Operations Department
	Department of Internal Medicine	Operations Air Cond.
	The Surgical Department	Intensive Care Unit (ICU)
	Elevators, Composers ,and Pumps	ICU Air Cond.
	Air Conditions	Maintenance Department
	Pediatric Treatment	Laboratory Department

In case of Main Public electrical grid source is ON all parts of hospital loads are supplied with electricity by main grid source. When public main source fails, the 400 KVA generator or 700 KVA generator will run to produce the needed power for hospital in order to supply only essential and very important loads. Selecting between 400 KVA or 700 KVA generator depends on previous configuration by adjusting traditional timers for delaying generators start up, when one of them start first the second will not start. If the 400 KVA or the 700 KVA generator fails (started first), the second will work immediately. If the two main generators fail, the 300 KVA after certain few seconds will run to supply very important loads.

The 300 KVA generator as in (FG Wilson,2014 ), has a standby capacity of 300KVA /240 KW with power factor 0.8; that means the generator can produce 240 KW for limited duration not for long period. In our situation (main electrical grid be OFF at least 8 hours) when we select the 300 KVA to produce electrical power for 8 hours (long period), then the 300 KVA must work as prime generator with rated capacity of 275KVA/220KW.

The 400 KVA generator as in (FG Wilson,2014 ), has a standby capacity of 400KVA /320 KW with power factor 0.8; that means the generator can produce 320 KW for

limited duration not for long period. When we select the 400 KVA generator to produce electrical power for 8 hours (long period), then the 400 KVA generator must work as prime generator with rated capacity of 350KVA/280KW.

The 700 KVA generator as in (Cummins Power Generation Inc.,2007), has a standby capacity of 700KVA /560 KW with power factor 0.8; that means the generator can produce 560 KW for limited duration not for long period. When we select the 700 KVA generator to produce electrical power for 8 hours (long period), then the 700 KVA generator must work as prime generator with rated capacity of 640KVA/512 KW.

KAMAL EDWAN hospital loads vary from 65 kW to 350 kW, that means when load 65kW and the 400 KVA generator run to produce power to supply hospital loads. This means that the percentage loads on generator is 23% resulting in extremely low load generator operation and that will lead to damage of generator and reduce its life cycle and high fuel consumption. But we cannot select the 300 KVA generator because the structure of electrical distribution board will not allow the 300 KVA generator to supply all loads.

The 700 KVA generator power at 50% load is 256 KW, to prevent the 700 KVA generator go to low load operation the hospital loads must be greater than 256 kWh. So we can select the 700 KVA generator to supply hospital loads at peak load during summer season for short period (3 to 5 hours). If we are looking at the hospital loads hours (when loads exceeds 256 kW when main electric grid off in July and august) through the year, it doesn't exceed more than 100 hours. Thus, the 700 KVA must run only during this period so the generator run in the safe side only 100 hours over the year. That means the 700 KVA generator is not suitable for KAMAL EDWAN hospital.

MTS,s as we see in Figure (1.2) consists of two modeled case circuit breaker (MCCB) and mechanical interlock to ensure one of MCCBs is connected and the other is disconnected to avoid dangerous short circuit when two of them concurrently connected. At the entrance of each MTS, there are two MCCBs that

have the same function of MTSs MCCBs and the existence of these MCCBs is not valuable and increases construction cost of MTSs.

#### **1.4 Previous Study:**

Valuable researches have been presented in literature for transferring electrical power and automatic transfer switches (ATS). Lot of procedures and configurations used for management power sources and transferring electrical power to reduce fuel consumption and maintenance cost of diesel power generator and to ensure continuity of services have been attracting much research interest .

In 2005, Bagen and Billinton (Bagen and Billinton,2005) presented a new simulation technique to evaluate different operating strategies for small stand alone power systems using wind and/or solar energy. The advantage and disadvantage of these strategies were analyzed with reference to reliability, diesel fuel savings, back-up diesel average start-stop cycles and average running time .

In 2006, Parise et. al. (Hesla, Paris, and rifaat,2006) proposed a new methodology to close the gap between the traditional system design integrity studies and their counterpart studies associated with system operational safety aspect.

In 2006, Parise and Hesla (Parise, and Hesla,2006) introduced basic concepts and a logic method to plan the operating procedures, that would facilitate the design and the training by PC program also: it would offer a “string” to face the “labyrinth” of complex operating procedures.

In 2007,Katiraei and Abbey (Katiraei and Abbey,2007) developed a design methodology and analysis approach (**energy-flow model**) for unit sizing of an autonomous wind-diesel system. Hence, maintaining a minimum loading requirement for diesel units in operation reduced the overall wind energy contribution to electricity supply of the network during low load periods and/or high wind conditions. Re-sizing of the diesel units with respect to the wind plant and implementation of appropriate cycling strategies to optimize spinning capacity of the

diesel plant can help improve the wind energy contribution. This paper considered a selected set of commercially available diesel generators and used the annual load duration curve of the system to determine optimal diesel unit sizes that meet: 1- improve overall diesel plant efficiency and maximize the fuel savings, 2- maximize total wind energy contribution to the grid. 3- introduce a diesel cycling and dispatch strategy that maintains adequate loading on multiple diesel sets while minimizing the number of diesel on/off cycling.

In 2009, Parise et. al. (Paris,Hesla, and Rifaat,2009 ) dealt with the architecture of a power system and the combination of procedures in the operation on a nodes system. It shown the impact of the architecture on the comprehensive procedures for a complex system. To enhance the integrity of power system analysis and operation, the design could adopt the cut & tie rule, introducing ring configuration and floating nodes. The suggested advanced approach assisted in the elaboration of the procedures for switching from one set or configuration of a power system to another and helped the training of operators in defining the instructions to be used in the development and the operating of each power system.

In 2009 and 2010, Mizani and Yazdani (Mizani and Yazdani,2009), and Asato et. al. (Asato ,Goya, Uchida, and Senjyu,2010 ) talked about the process of reducing diesel fuel consumption costs for diesel generators in isolated areas by integrating alternative renewable energy sources such as energy produced from wind and solar power with diesel generators.

In 2013, Parise et.al. (Parise, Hesla, and Parise,2013) resembled the traffic intersections with node connection of multiple sources, the researcher tried to set a Transition Theory to simplify the designing of ATS. The author in this paper suggested a new approach for ATS:(double node two ATS 's) each ATS combined with three circuit breaker .

In 2014, Parise et.al. (Parise, Hesla, Parise, and Pennacchia,2014) highlighted how service continuity plans of Business Continuity Management(BCM) applied the switching/operational procedures in a micro-systemic approach founded on the coordination of the nodes/intersections complying with their genetic code. The

management of a complex system with multiple sources has to be planned with guidelines and strategies that consider the differing reliabilities of the utilities sources, the actual system configuration in its parts, and the loads exigencies of the buildings. Operation of a complex system must not be organized with a comprehensive approach (macro approach) that studied all the links among the system nodes in the transitions of the authorized statuses. It must be organized node by node with a local approach (micro approach). Each node must respect only the constraints with the adjacent nodes by applying "flock logic".

In 2014, Tereshchenko , Pichkalov ,and Yamnenko (Tereshchenko , Pichkalov ,and Yamnenko, 2014)proposed a control strategy for diesel fuel consumption as an aspect of resource saving in hybrid uninterruptible power systems. Conditions of rational fuel consumption for diesel generator were obtained. Fast acceleration of the DG when operating without storage battery(UPS) to load requires significant fuel. Parallel operation of the diesel generator and storage battery allowed decrease fuel consumption for 10- 17% at acceleration and deceleration intervals.

In 2014, Moshi et. al. (Moshi, Pedico, Bovo, and Berizzi, 2014) applied General Algebraic Modeling System (GAMS) and Genetic Algorithm (GA) to optimize generation scheduling of four diesel generators in a planned microgrid to minimize power generation costs.

In 2015, Pushpavalli et. al.(Pushpavalli, Nivetha, and Dhanasu, 2015) illustrated the switching in case of high current rating which damages in main ATS or MTS and reduce its lifecycle.The authors suggested replacing main ATS by group of relays. In other world, instead of connecting all loads to single main ATS, they suggested dividing the loads to multiple groups and each group was connected to a relay. The function of relay was to switch between the main supply and standby supply for feeding loads with electrical power. To protect the standby supply against over load current, the paper used a PLC to disconnect part of loads to ensure the current within the standby is rated current.

In 2015, Galande and Autade (Galande and Autade,2015) illustrated a low cost ATS design. The controlling of ATS depended on microcontroller chip and on computer for monitoring.

### **1.5 Thesis Objectives:**

- Develop a novel methodology in designing the main electrical distribution boards and automatic and manual transfer switches for important Institutions.
- Provide new design with proper procedures and configurations to ensure the continuity of electrical power for all situations.
- Use bulled control system via PLC for energized proper generator or generators to ensure low fuel consumption and low maintenance .
- Provide flexibility of the proposed approach to allow more choices of electrical power transfer specially in emergency situation .
- Classify and connect the loads to the switching boards accordingly.

### **1.6 The Motivation:**

During my work in Engineering and maintenance department in KAMAL EDWAN Hospital, many problems in electrical distribution boards and in generators I have been facing on daily basis. I watched, firsthand, the inefficient of electrical distribution boards and if we redesigned it with a new approach it will lead us to increase the flexibility of electrical power transfer and leads us to full benefit from all available electrical power generators. The suggested approach will also lead us to reduce generator fuel consumption.

### **1.7 The Contribution:**

The proposed approach in designing electrical distribution boards and automatic and manual transfer switches will increase the flexibility in transferring electrical power in important and sensitive Institutions like hospitals that ensure electrical availability for every loads in hospital. Availability of using any generator to supply hospital



with electricity whether we can use residual generator or group of generators when needing more capacity to ensure full electricity covering and decreases the stress on the generators. The proposed control will reduce fuel consumption by selecting which generator to run to cover hospital electrical power demand without human monitoring and interference.

### **1.8 The Methodology :**

Redesign of Kamal Edwan Hospital electrical distribution boards and Automatic and Manual Transfer switches (ATS's and MTS's ) to achieve the flexibility and availability of all generators to supply any loads in hospital. This approach will be satisfied by adding and Rearranging ATS's and MTS's .

I Propose to use PLC for monitoring hospital electrical power demand and to select which generator to run. Selecting suitable generator size will reduce fuel consumption.

### **1.9 Thesis Organization:**

This thesis is organized into five chapters; Chapter 2 contains general background about Impact of generator Low Load Operations and its efficiency of fuel consumption, also it gives brief explanation about load curves and the consequent definitions; Chapter 3 covers the proposed Electrical Power System structure; Chapter 4 discusses the control system to increase efficiency of management power sources and fuel consumption in electric power system in KAMAL EDWAN hospital, Results and simulation also presented in this chapter; Chapter 5 gives conclusions.

## **Chapter 2**

### **Power Generation and Loading**

#### **2.1 Introduction:**

For decades diesel generators have been used to provide electricity to remote sites. Gasoline, natural gas and propane are also options for generators, typically for smaller electric loads. Propane and diesel generators offer the best levels of service for full time systems. Gasoline generators are generally cheaper to buy, but more expensive to operate.

The process of producing energy using diesel generators utilizes 10% of the fuel on the generator itself (as auxiliary power) such as moving air, charging battery, water and oil movement to keep the engine cool and lubricated, as well as friction by mechanical parts. 60% of scientific heat of the fuel is converted to waste heat, which is displaced primarily through the radiator, but also as radiated heat from the exhaust, muffler and the engine itself. This leaves the remaining 30% to do the work required, in this case, producing electricity. At best, the efficiency of diesel generator produces 3.7 kWh of electricity for every burned liter of diesel fuel ("Guide to Best Energy" 2011).

#### **2.2 Generator Efficiency:**

Generators run most efficiently when they're 80% loaded ("Guide to Best Energy" 2011). Table (2.1) shows the relationship between fuel consumption and the loading percentages were it indicates that the best percentage is obtained with 100% loading. At 10% loading, 0.57 liters is required for every kWh while at 75% loading less than half of that, 0.26 liters per kWh is required.

#### **2.3 Impact of Low Load Operations:**

Diesel engines generators operate optimally at medium to high loads. It is suspected that operations at low loads may increase operational problems; thus, the engine can

be damaged frequently. It is also suspected that the negative effects of low load operations may violate the exhaust emission regulations.

**Table (2.1):** Fuel Consumption versus load chart ("Guide to Best Energy" 2011).

Load (%)	RPM	L/kWh
0	1000	N/A
0	1800	N/A
5	1800	0.93
10	1800	0.57
15	1800	0.44
25	1800	0.36
30	1800	0.33
40	1800	0.30
50	1800	0.28
75	1800	0.28
100	1800	0.26
Test performed on an Isuzu series 4HK1 tier 3, 2007 100kW machine		

A number of diesel engine damages has been reported over the last few years that possibly can be linked to low load operations (Tufte, 2014,p. 1).

Low load operations of diesel engines are defined as engine operations at loads below 40% of maximum continuous rating. Engine loads below 25% are defined as extreme low loads. Engine loads in the range of 40–80% is defined as regular generator operation load (Tufte, 2014,p. 4). Definitions of the entire load range are presented in Table (2.2).

**Table (2.2):** Load levels in percentage of maximum continuous rating

0 – 25%	Extreme low load
25 – 40 %	Low load
40 – 80 %	Regular generator operation load
80 – 90 %	High load
90 – 100 %	Extreme high load

Low load operations of diesel engines cause lower cylinder pressure; thus, lower temperature. Low temperature can lead to ignition problems and poor combustion

which causes increased soot formation and aggregation of unburned fuel in the cylinder. Soot and unburned fuel deteriorate the piston ring sealing and decrease its efficiency by allowing hot combustion gases, soot particles and unburned fuel to leak past the piston rings. This results in increased lubricating oil consumption and fuel dilution. Fuel dilution of the lubricating oil reduces the viscosity which can collapse critical oil film thicknesses. This can cause premature wear of pistons, rings, liners and crank case bearings. The mechanisms of low load lead to a cycle of degradation which means that diesel engines that run at low loads for longer periods of time can become irreversibly damaged. The damage case presents an engine crankcase breakage initially caused by piston scuffing from lubrication oil breakdown after excessive low load operations (Tufte, 2014,p. v).

Engine manufacturers agree that low load operations affect the engine operation negatively, but they do not want to confirm that low load operation increases the engine damage frequency. It is consensus among the engine manufacturers that the engines must be loaded to at least 50% of rated power regularly during low load operations to prevent operational problems. The time interval and load requirements can vary from one engine to another and depending on the engine design (Tufte, 2014,p.vi ).

## **2.4 Generator Optimization:**

Generator optimization refers to properly matching the generators output to the load, and running the generators in the most efficient manner. Many remote facilities have generators that are much larger than the load requires because buying a bigger generator is comparatively inexpensive. It is the increased fuel consumption of a larger generator that is the expensive part("Guide to Best Energy", 2011). A generator is much less efficient at low load than at full load. A larger generator will consume more fuel than a properly sized generator. Electricity demand is not constant; it has peaks that can be 3 times higher than the low demand times.

Installing two or three generators allows one generator to be sized for the low load, and another to handle the peaks. Many sites are reluctant to change generators to a

more suitable size, or install multiple generators because of the “high costs” of new generators. These are economic fallacies because the fuel savings is much greater than the initial extra cost. Small engine working harder will use less fuel, and will burn it cleaner. Diesel generators are most efficient at 80% loading.

## 2.5 Load priority panel:

A priority load panel is necessary to automatically control power down of optional loads. This allows a smaller generator to be used at emergency situation to ensure continuity of electrical service for important loads. In the following section we will review the Load Curve principles that help in designing and selecting generators size.

## 2.6 Load Curve:

The power station is constructed, commissioned and operated to supply required power to consumers with generators running at rated capacity for maximum efficiency. This section looks at problems associated with variable loads on power stations, and discusses the complexities met in deciding the make, size and capacity of generators units that must be installed in a power plant to successfully meet these varying energy demands on a day to day basis.

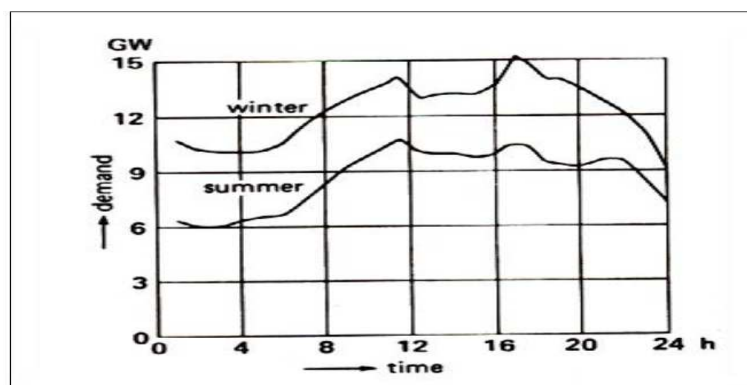


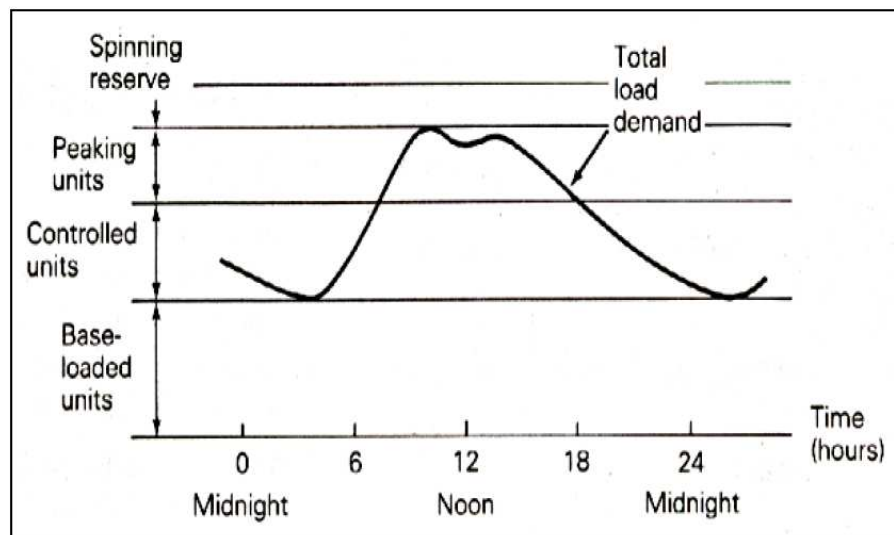
Figure (2.1): Daily load curve of a certain power system.

The load on a power station varies from time to time due to uncertain demands of consumers as shown in the Figure (2.1). Energy demand of one consumer at any given time differs from another consumer.

Load curves are useful for generation planning and enable station engineers to study the pattern of variation of demand. They help to select size and number of generating units and to create operating schedule of the power plant.

## 2.7 Important definitions:

To realize previous introduction, it is important to mention that load is divided into number of categories like private, public, commercial, entertainment, hospitals, transport, industrial, waterworks, and street light ,etc. After preparing the load sheet for a locality indicating the total load in each category (each category may have different types of loads such as light, fan, refrigerator, heater, pump ,etc), load curve is plotted for each category over a day (usually every hour or every 30 minutes).Then the final load curve for the locality is obtained by summing them. This is daily load curve for that locality as shown in the Figure (2.2), and following offers basic definitions(In Hijo,2011):



**Figure (2.2) :** Daily load curve respect to range of demand.

**Base load:** The unvarying or minimum regular demands on the load curve.

**Intermediate load:** The area between minimum regular demands and beginning of peak loading and reduced when demand is low on the load curve.

**Peak load:** Various load peak demands on the load curve.

**Maximum demand (MD):** The greatest load demand on the power station during a given period or the highest peak on the power station load curve.

**Demand Factor (DF):** Ratio of maximum demand to maximum possible load and this is usually less than one as shown below equation

$$\mathbf{DF} = \frac{\text{Maximum Demand}}{\text{Connected Laod}} \quad (2.1)$$

**Average load:** This is the average of loads on the power station for a given period.

**Daily average load:** Average of loads on a power station in one day and it is equal to the total number generated power (KWHrs) over 24 Hrs.

**Monthly average load:** Average of loads on a power station in one month and it is equal to the total number generated power (KWHrs) over 720Hrs(30 day).

**Yearly average load:** Average of loads on a power station in one year and it is equal to the total number of units over year hours (8760 Hrs)

**Load factor (LF):** The ratio of the average load to maximum demand and it is approximately equal or less than equal one as below equation.

$$\mathbf{DF} = \frac{\text{Average Load}}{\text{Maximum Demand}} \quad (2.2)$$

This means that: High loading factor consequent with low cost per unit generated.

**Diversity factor (DiF):** The ratio of the sum of all individual maximum demands on the power station to the Maximum demand on the station. Consumer maximum demands do not occur at the same time; thus, maximum demand on power station will always be less than the sum of individual demands as following equation .

$$\mathbf{DiF} = \frac{\text{Individual Maximum Demand}}{\text{Total Station Maximum Demand}} \quad (2.3)$$

This means that if high diversity factor (DiF) exists, then we have low maximum demand (MD) and so low plant capacity with low investment capital required.

**Plant capacity factor (PCF):** The ratio of actual energy produced to the maximum possible energy that can be produced on a given period. This indicates the reserve capacity of a plant.

**Load Curves:** A load curve is a plot showing the variation of load with respect to time. Load curve of a locality indicates cyclic variation, as human activity in general is cyclic. This result in load curve of a day that does not vary much from the previous day. The following load curves are used in power stations:

**Daily load curve:** Load variations captured during the day (24 Hrs), recorded either half-hourly or hourly.

**Monthly load curve:** Load variations captured during the month at different times of the day plotted against No. of days.

**Yearly load curve:** Load variations captured during the Year, this is derived from monthly load curves of a particular year.

#### **Information obtained by the load curves:**

- Area under load curve = KWH generated.
- Highest point of the curve = MD
- (Area under curve) / (by total hours) = Average load
- Based Load = Minimum Load.

Helps to select size and number of generating units. Helps to create operating schedule of the power plant.

#### **The following must be considered when selecting the generating units:**

- Number and size of units to be approximately fit the annual load curve.
- Units to be of different capacities to meet load requirements.
- At least 15-20% of extra capacity for future expansion should be allowed for.
- Spare generating capacity must be allowed for to cater for repairs and overhauling of working units without affecting supply of minimum demand.
- Avoid selecting smaller units to closely fit load curve.



## Chapter 3

### Proposed Electrical Power System Structure

#### 3.1 Modification in generators Size:

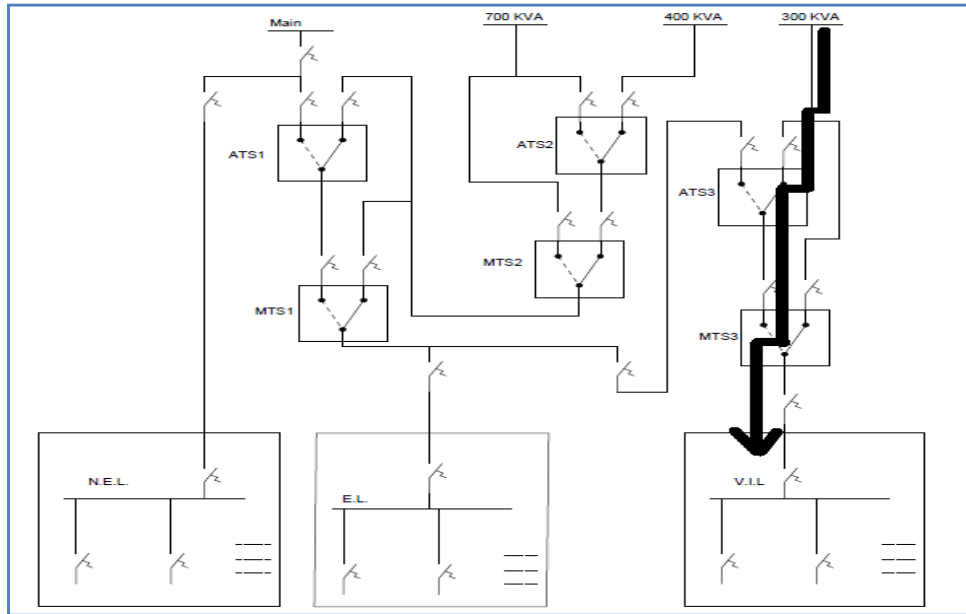
When we looking in KAMAL EDWAN Hospital Load curves in figure (1.1) we found the base load (minimum load demand ) is 65 KW, and the maximum demand load is 350 KW, and average load is 210 KW, so I select FG Wilson 300 KVA with rated prime capacity 220 KW to supply hospital loads at low loads conditions, when 300 KVA generator loading at 40% its output power is 88 KW near to KAMAL EDWAN Hospital minimum load demand. I select FG Wilson 400 KVA with rated prime capacity 280 KW to supply hospital average loads, when 400 KVA generator loading at 75% its output power is 210 KW, so it suitable for hospital average load conditions. And I select FG Wilson 500 KVA generator with rated prime capacity 365 KW to supply hospital loads at high loads conditions.

#### 3.2 Modification in Main Electrical Distribution Board :

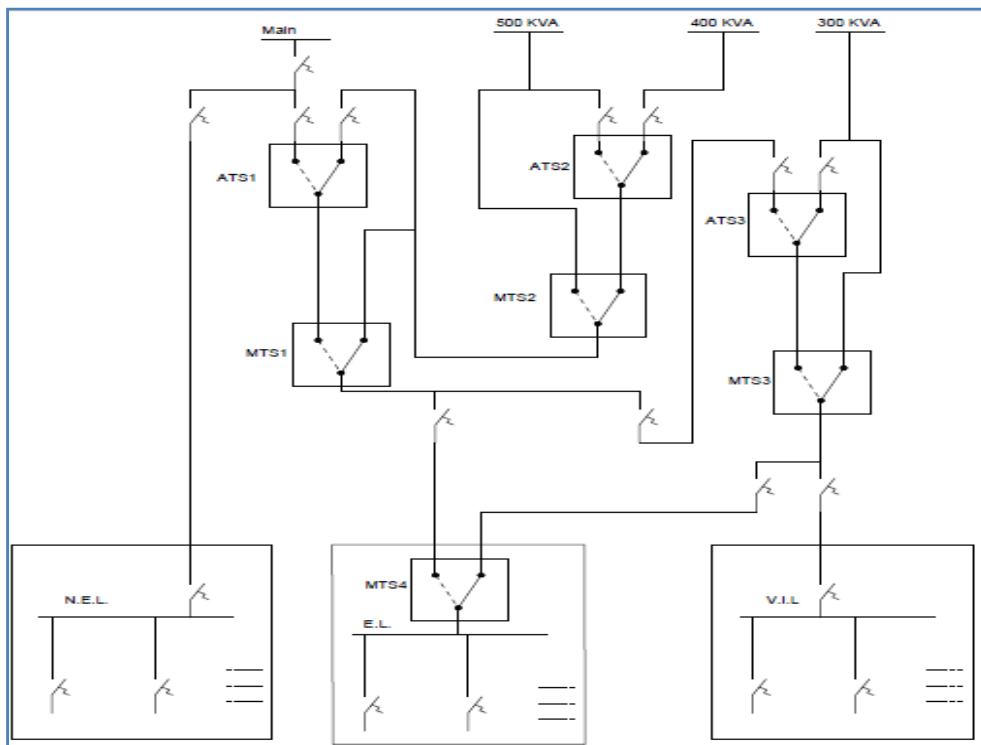
Main electrical distribution board in KAMAL EDWAN Hospital does not allow the 300 KVA generator to serve all hospital loads. 300 KVA generator only run at emergency situation when all electrical power sources have been fault and it run for supplying the VIL loads .KAMAL EDWAN Hospital loads in several times and for long periods are low and both main generators (700 KVA and 400 KVA) when it supplying are running in low loading case and the loads in this period it can be supplied by 300 KVA generator but the Main electrical distribution board not allow it to supply except VIL as we see in figure (3.1).

To solve this problem I propose to add MTS4 in EL electrical distribution board which have of two sources ,one from the output of MTS1 and the second from MTS3 as we see in figure 3.2. When we need to supplying EL loads with 300 KVA generator at low load period (specially at spring and autumn seasons) easily switch MTS4 manually to connect EL with 300 KVA source .

As we said in chapter 1, there is no need for MTS's prior MCCBs and the overall suggested Electrical Distribution board illustrated in figure 3.2 .



**Figure (3.1):** 300 KVA generator supplying VIL loads only

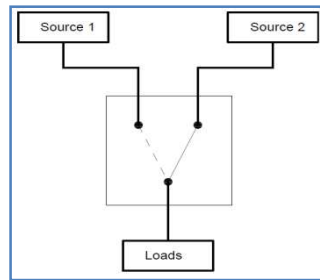


**Figure (3.2):** Suggested electrical power distribution board

### 3.3 System Components Descriptions:

#### 3.3.1 Manual Transfer Switch (MTS):

The function of MTS is to connect load manually with one of two sources that linked with MTS. The technician person can select manually between two sources to supply loads. Figure (3.3) shows MTS single line diagram.



**Figure (3.3):** MTS single line diagram

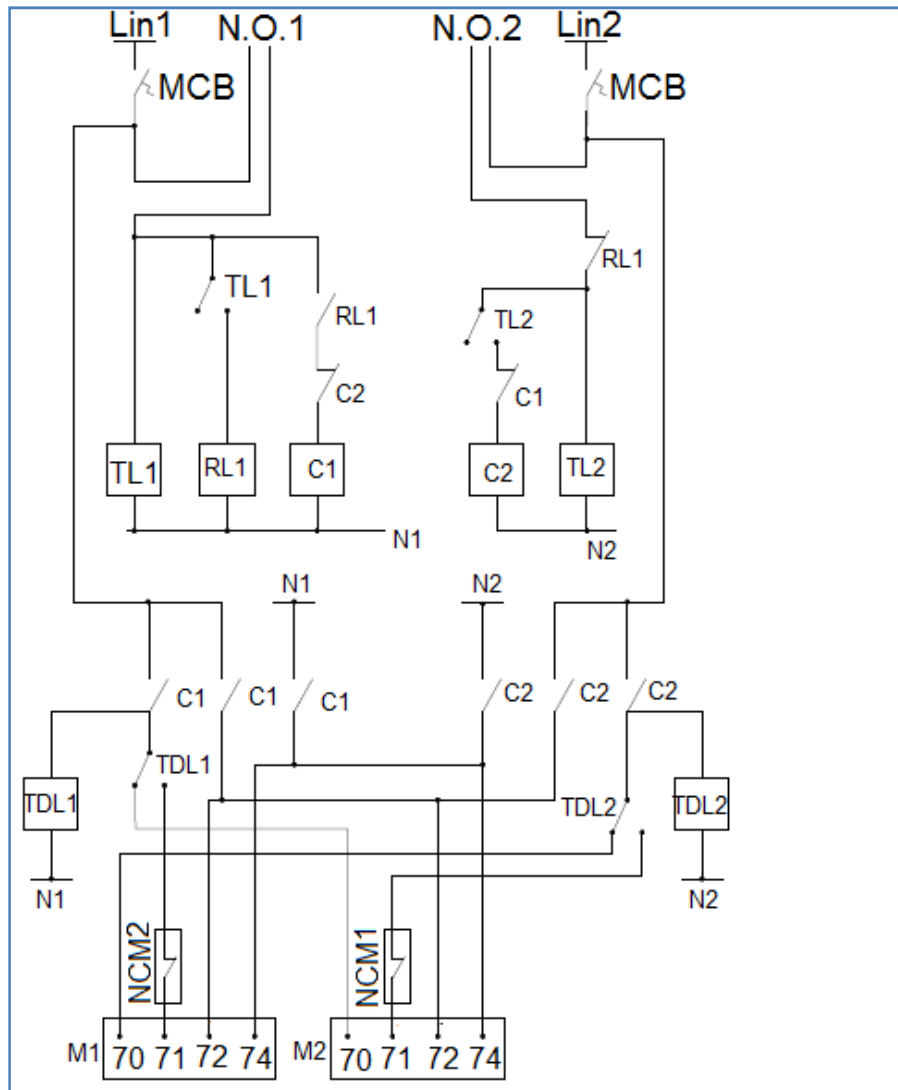
MTS contains two MCCBs. The output of MCCBs are linked with copper bus bar and connected with load. The input of each MCCB is connected with residual source. The two MCCBs cannot be connected at the same time because of mechanical interlock between them that enable one of MCCBs to be connected only. Figure (3.4) shows MTS in electrical distribution board.



**Figure(3.4):** Indoor and Outdoor of MTS board in electrical distribution board

### 3.3.2 Automatic Transfer Switch (ATS):

The function of ATS is to switch between two sources in order to connect to load automatically using electrical signal from control unit. ATS contains two MCCBs , as MTS, but with special motor added to each MCCB. The MCCB motor connects and disconnects the MCCB using electrical power. The MCCB motor has four terminals [70 , 71 , 72 , 74]; 72 and 74 are supplied with 220 VAC power, when 70 terminal supplied with 220 VAC, the MCCB is disconnected but when 71 terminal is supplied with 220VAC, the MCCB is connected. Figure (3.5) shows the control diagram that is used for switching between ATS sources to connect to loads .



**Figure (3.5):** Control Diagram for ATS.

Where:

<b>C1,C2</b>	small contactors.
<b>RL1</b>	Relay .
<b>TL1 , TL2 , TDL1 , TDL2</b>	Timers .
<b>MCB</b>	6A Miniature Circuit Breaker .
<b>M1,M2</b>	MCCBs's motor's terminals.
<b>NCM1</b>	Normally Close Auxiliary Contact for M1
<b>NCM2</b>	Normally Close Auxiliary Contact for M2
<b>Lin1</b>	220 VAC from source 1
<b>Lin2</b>	220 VAC from source 2
<b>N1</b>	Neutral terminal from source 1
<b>N2</b>	Neutral terminal from source 2
<b>N.O.1 , N.O.2</b>	Normally open contact used by control unit for actuating MCCBs's Motors

Figure (3.6) shows the ATS in electrical distribution board.



**Figure(3.6):** Indoor of ATS board in electrical distribution board

### 3.3.3 Generators:

In our proposed approach there are three generators. First is FG Wilson 300 KVA generator designated for emergency and low loads situation, second is FG Wilson 400 KVA designated for medium loads, and third is FG Wilson 500 KVA designated for high loads (FG Wilson,2014 ).

Electrical diesel Generator can be run manually or automatically by setting generator panel, generator will run automatically by short (by control unit) between 3 and 4 terminals in generator control panel. Figures(3.7) shows FG Wilson generator control panel.



**Figure (3.7) :** FG Wilson generator control Panel

### 3.3.4 Methodology of Control:

Programmable logic controllers (PLCs) have been an integral part of factory automation and industrial process control for decades. PLCs control a wide array of applications ranging from simple lighting functions to environmental systems to chemical processing plants. These systems perform many functions, providing a variety of analog and digital input and output interfaces; signal processing; data conversion; and various communication protocols. All of the PLC's components and functions are centered around the controller, which is programmed for a specific task.

To achieve optimal control for starting and selecting suitable generator in order to supply hospital loads while satisfying efficient fuel consumption and avoiding

running generator at low load situation based on hospital loads, I propose using PLC for monitoring hospital loads and for deciding which generator must run to supply loads with needed power. I used Siemens PLC S300 CPU 314C 2PN/DP for this process. S300 CPU 314C 2PN/DP PLC has 24 Digital inputs, 16 Digital outputs, 5 analog input, and 2 analog output that makes it suitable for our proposed control.

In our control system, we need to read 8 digital signals and 3 analog signals from system sensors, and the PLC will react and take decisions in running suitable generator and switching ATs depending on this input signals by actuating 9 digital outputs. Table (3.1) illustrates PLC's inputs and outputs signals.

**Table (3.1):** PLC's inputs and outputs signals Addresses and Description

<b>Input Add.</b>	<b>Description</b>	<b>Output Add.</b>	<b>Description</b>
<b>I0.0</b>	Main electrical fail signal	<b>Q0.0</b>	Starting 300 KVA generator
<b>I0.1</b>	300 KVA fail signal	<b>Q0.1</b>	Starting 400 KVA generator
<b>I0.2</b>	400 KVA fail signal	<b>Q0.2</b>	Starting 500 KVA generator
<b>I0.3</b>	500 KVA fail signal	<b>Q0.3</b>	ATS1 switching right line
<b>I0.4</b>	Signal from MTS4 refers to 300 KVA generator can supply ESL and VIL	<b>Q0.4</b>	ATS1 switching left line
<b>I0.5</b>	300 KVA not fail signal	<b>Q0.5</b>	ATS2 switching right line
<b>I0.6</b>	400 KVA not fail signal	<b>Q0.6</b>	ATS2 switching left line
<b>I0.7</b>	500 KVA not fail signal	<b>Q0.7</b>	ATS3 switching right line
<b>IW800</b>	Analog signal from Current Transf. CT refers to current flow measurement on line1	<b>Q1.0</b>	ATS3 switching left line
<b>IW802</b>	Analog signal from CT refers to current flow measurement on line 2		
<b>IW804</b>	Analog signal from CT refers to current flow measurement on line 3		

Detailed information about PLC's inputs and outputs signals and wiring illustrated in Appendix A .

Next chapter showed the PLC reactions to various situations and how it switch ATSS and running generator to avoid loss of electrical supplying and avoiding running generator in low load situation. Flowcharts and logic steps discussed in next chapter to facilitate understanding how the PLC respond.



## Chapter 4

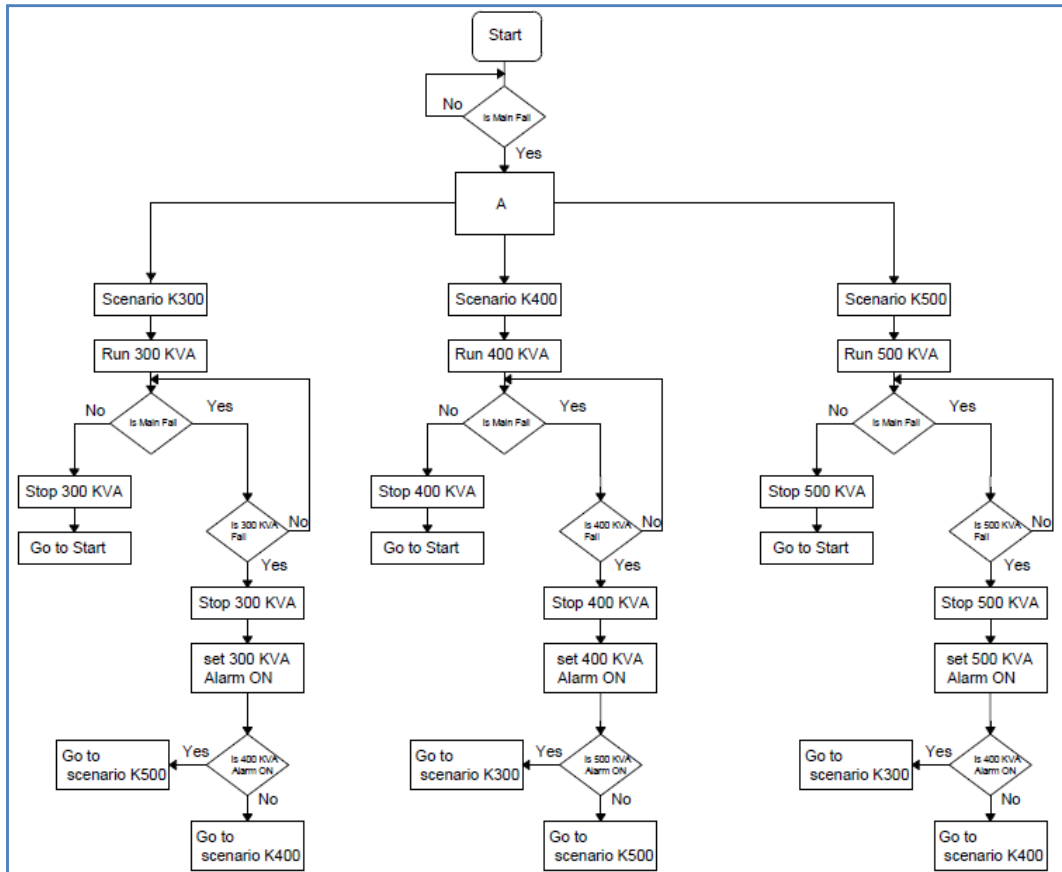
### Control, Simulation and Results

The control part will cover three issues: (1) management issue to ensure electrical service continuity and starting and stopping generators in the normal scenario and in emergency scenario, (2) selecting suitable generator size to supply loads depending on load demand size, and (3) switching procedure in ATSS.

#### 4.1 Controlling and running generators in emergency situations:

When electrical power is available from main electrical grid, the control system will not start up generators and will connect loads with main electrical grid source. When main electrical grid source fails, the control system immediately runs one of three generators depending on load demand (discussed in next section) usually the 400 KVA generator. If the 400 KVA generator fails to run or fails while working, then the control system starts the 500 KVA generator. If the 500 KVA generator fails, then 300 KVA will run to supply VIL. The previous procedure discussed one scenario but the control system contains more scenarios for good performance at emergency situation illustrated in figure (4.1).

In figure (4.1) we found box A which is responsible for selecting suitable generator size depending on load demands. Box A object is to avoid generator low loading or high loading. Box A will be discussed in detail in the next section. Connecting loads with sources depends not only on generators starting also on switching in ATSS as discussed in section 4.3.



**Figure (4.1):** Flow chart for selecting operating generators in emergency situations

#### 4.2 Controlling, running and transforming power depending on Load demands:

As illustrated in problem statement in chapter one, it is preferable for loading rate on generators to be between 40% to 80% of its rated maximum load; thus, the generators run at highest efficiency and low fuel consumption (Tufte, 2014,p. 4).

When we are talking about the 300 KVA generator, its capacity when it running as prime generator is 275KVA/220KW. Thus, at 40% loading on the 300 KVA generator the power produced will 88 KW and at 80% loading the power produced will be 176 KW. Therefore, when running the 300 KVA generator, the total load must not exceed 176 KW. Usually power factor PF for hospital loads is 0.9, so we can use this information to determine allowable maximum and minimum average current AVGC in three phases in each of Kamal Edwan hospital's generators.

In the proposed control system, digital current transformers CT are used to measure current flow through EL and VIL boards by converting current ampere measurement to small signals (4 to 20 mA) and send it to the PLC. By using this CTs' signals, the PLC understands load demands and decides on the preferable generator to supply when the main grid fail to supply and transforming loads from generator to another when loads exceed 80% of generators capacity or drops under 40% of generators capacity. Thus, we must determine maximum and minimum allowable AVGC for each generators.

To determine the maximum and minimum allowable loading for the 300 KVA generator as prime generator (running in long and continuous period exceeding 8 hours ), we need to solve the following equation

300 KVA Generator Average current AVGC at 40% of loading:

$$KW = \sqrt{3} * V_L * I_L * PF \quad (4.1)$$

Where:  $V_L = 400$  V and  $PF = 0.9$  then AVGC at 40% of loading is 140 A .

The 300 KVA generator average current AVGC At 40%,60%,80%,and 85% of its loading capacity are 140A, 210 A, 280 A, and 300 A respectively.

When hospital load demands are extremely low, the 300 KVA generator can supply EL and VIL by configuring MTS4 to combine EL board with VIL board and by auxiliary contact inside MTS4 which responsible to inform PLC that the 300 KVA generator can supply VIL and EL.

The PLC saves current flow measurements drawn by VIL and EL boards every 10 minutes. Then when main electrical grid fails, the PLC will restore current measurements and decide which preferable generator size to run for supplying hospital loads.

When loads exceed 80% of generator capacity, then the control system will start the larger generator only after a determined time period (30 minutes). Giving proper time period for transforming from generator to another reduces the number of starting

generators and reduces the number of instantaneous disconnecting electrical power to the loads that could damage the hospital's systems .

When loads exceeding 85% of generator capacity, then the control system will quickly transform loads to larger size generators after short period of time (10 minutes). Quick transferring saves generators from damage because of high loading.

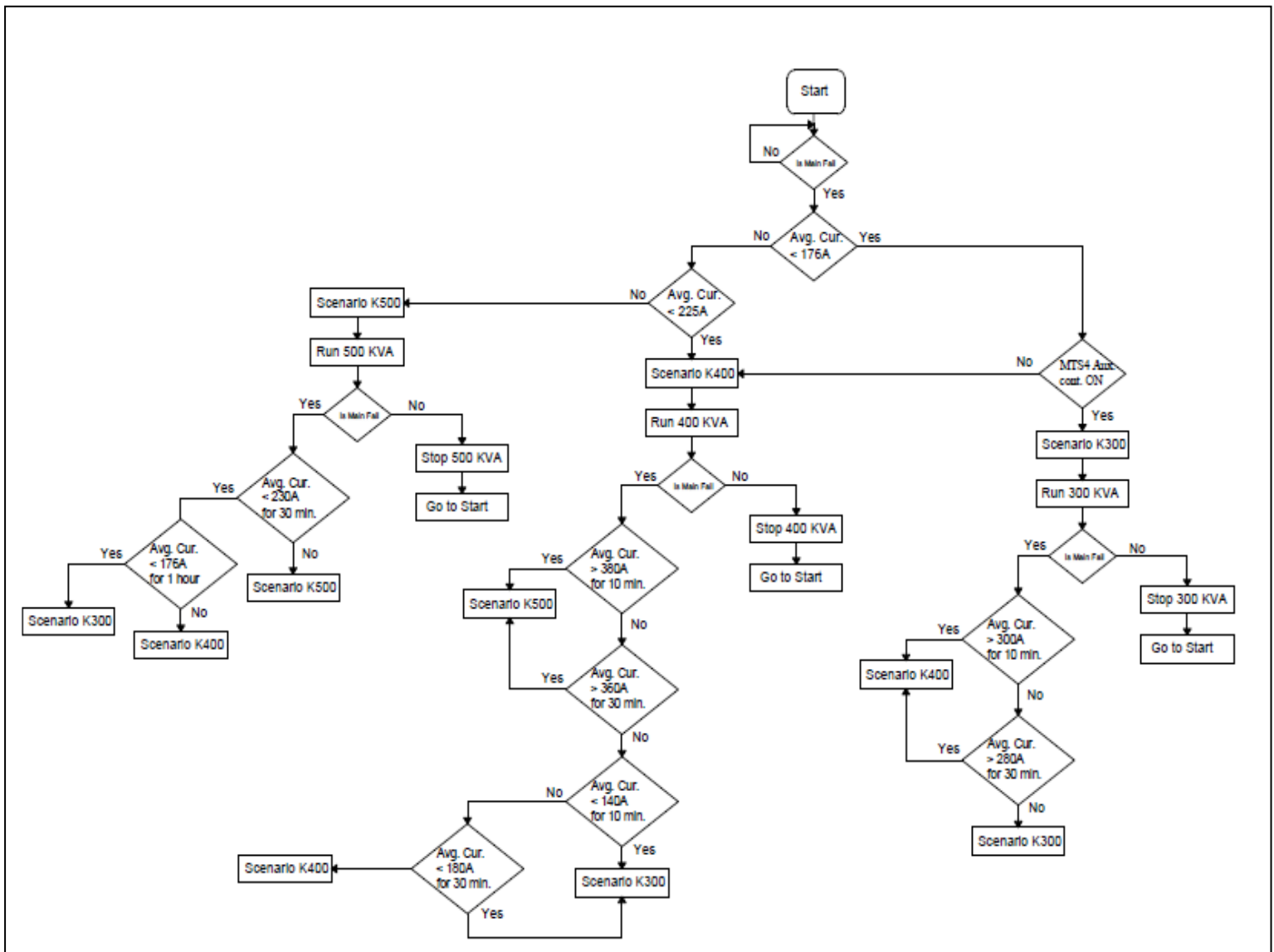
Table (4.1) shows the generators electrical power produced at 40%,60%,80%,and 85% of loading. These values are considered the main inputs for the control system to decide which generator to run.

**Table (4.1):** Average Current ( AVGC ) produced by 300KVA,400KVA ,and 500 KVA generator at 40%,60%,80%,85% of their capacity.

<b>Gen.</b>	<b>Gen. Prime Capacity</b>	<b>AVGC at 40% loading</b>	<b>AVGC at 60% loading</b>	<b>AVGC at 80% loading</b>	<b>AVGC at 85% loading</b>	<b>AVGC at 100% loading</b>
<b>300KVA</b>	275KVA/ 220KW	140A	210A	280A	300A	350A
<b>400KVA</b>	350KVA/ 280KW	180A	270A	360A	380A	450A
<b>500KVA</b>	455KVA/ 364KW	230A	340A	464A	490A	576A

The proposed control uses values defined in Table (4.1) in order to select a suitable generator that ensures loading on generator not to exceed 80% of generator's capacity and does not drop below 40% of its capacity. When loads exceed 80% of generator's capacity, the system will automatically energize the larger generator and transfers loads to it. When loads drop below of 40% generator's capacity, then the control system energizes the smaller generator and transfers loads to it.

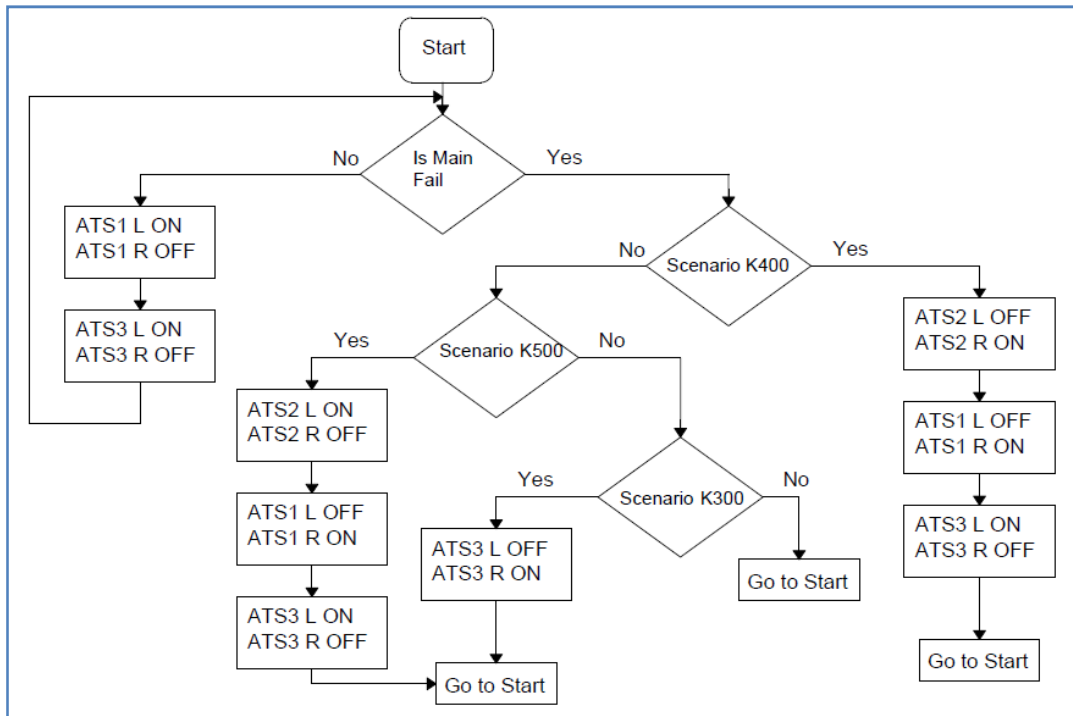
During normal operation when the main source is ON (public electrical grid), the system saves amperes measurements every 10 minutes. As soon as the main electrical power supply fails, then the system recovers the last measurements in previous 10 minutes and calculates the average current. If the average current is below the 60% of 300 KVA generator's capacity, then the 300 KVA generator will run to supply loads, or if the average current is below 60% of the 400 KVA generator's capacity, then the 400 KVA generator will run to supply loads; otherwise, the 500 KVA generator will run to supply loads. Figure (4.2) shows the flow chart with the rules and the logic for selecting generators depending on load demands.



**Figure (4.2):** Flow chart for selecting generator size depending on load demands

### 4.3 Control process in switching of ATSS:

In this section we will talk about switching and selecting sources. The main electrical distribution board contains three ATSS: ATS1 is responsible for connecting the hospital loads with the main electrical grid or with electrical power coming from ATS2, ATS2 is responsible for connecting ATS1 with the 400 KVA (right side) generator or the 500 KVA generator (left side), and ATS3 is responsible for connecting loads with the 300 KVA generator (right side) or with electrical power available from ATS1. Figure (4.3) shows the flow chart for switching in ATSS depending on available power source.

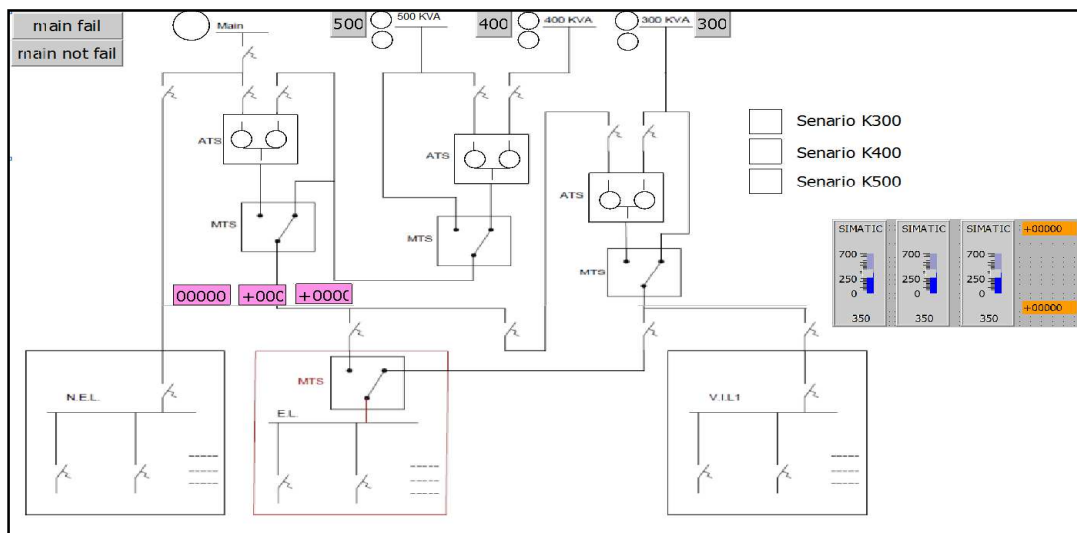


**Figure (4.3):** Flow chart for switching in ATSS

Appendix B shows a complete PLC ladder program that is used in the control process.

#### 4.4 Simulation and Results:

This section shows simulation and results. To test our control approach we will assume that there is fail in main electric public grid and the hospital getting electrical power only from its three diesel generators for all day hours. First we will simulate the system as currently built in KAMAL EDWAN hospital electrical power system, and then we will simulate our suggested control approach .The simulation applied for one day for each season. Simulation process achieved by using Siemens TIA portal Version 11 and S7-PLCsim. First to facilitate and imagine our project, must construct simulation panel on TIA program as following figure.

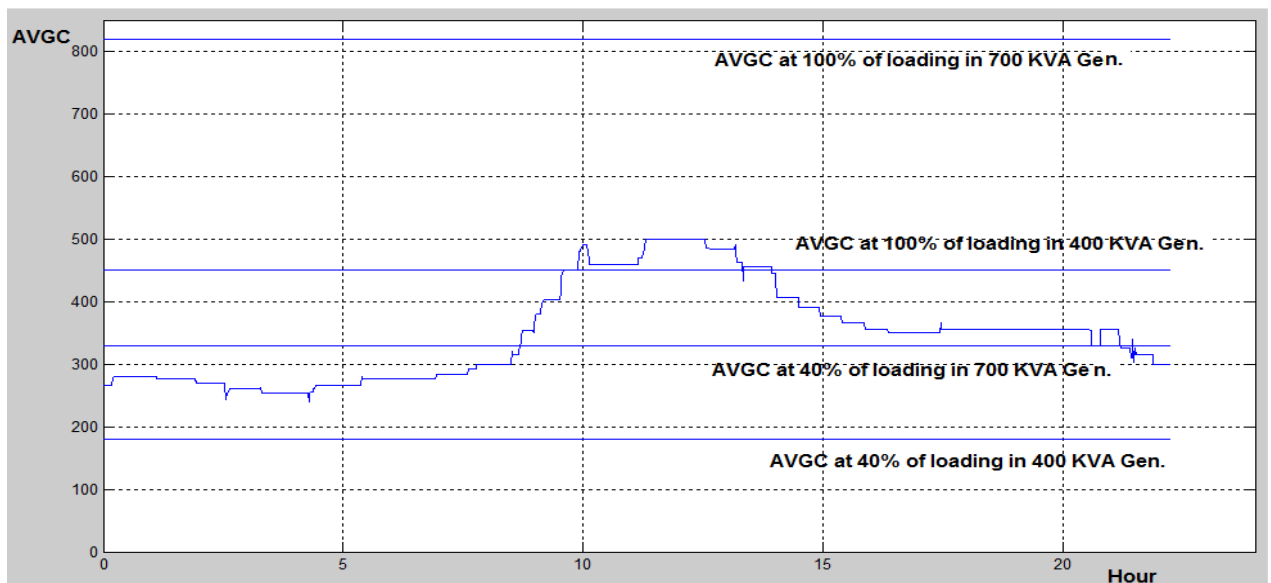


**Figure (4.4):** Simulation graphic user interface for testing suggested control system.

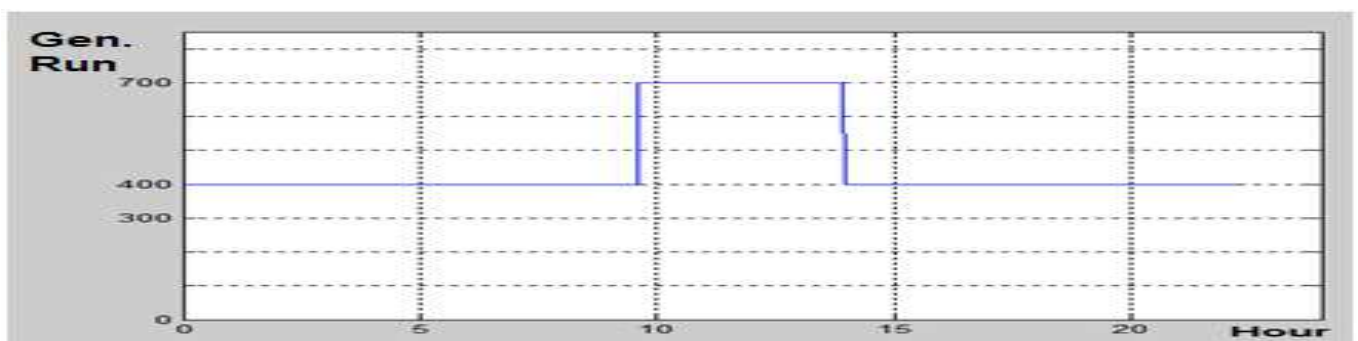
When main electrical grid getting OFF 400 KVA generator run to supply hospital with electrical power every time excepting of few hours in summer season when 400 KVA generator shutting down due to of high loading then 700 KVA generator starting to supply hospital loads with electric power.

I select three load curves in several day, First in summer (specifically in august), second in spring (specifically in April), and in autumn (specifically in September), the following figures show three load curves and time period of running generators as in existing electrical power system and as suggested approach when the main electrical grid have been fault .

In August, In old electric power system as we see in figure(4.5) loading on 400 KVA generator is between 50% to 100% but there is no automatic transferring loads to 700KVA generator when loading on generator exceeding 90% that may leads to damage generator, when loading on generator exceeding 100% of 400 KVA generator capacity then the generator will shut down due to of high loading and then system will start 700 KVA generator and supplying hospital with needed power. There is no automatic transferring loads to 400 KVA generator when AVGC drops to 330A (40% loading on 700 KVA generator) that make 700 KVA generator running in low load case and the transferring to 400 KVA will done manually by shutting down 700 KVA generator by expert technician.



a)

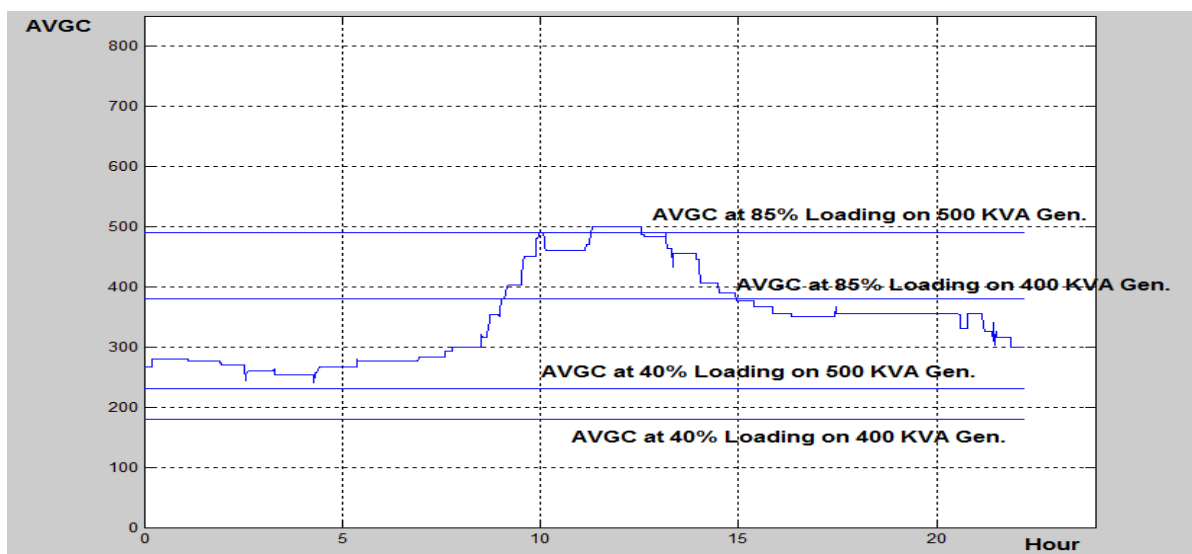


b)

**Figure (4.5):** a) Hospital load curve in August for one day and, b) time period of running generators in old system.



In our proposed electric power system as we see in figure(4.6) 400 KVA generator running in period between 12:00 Am to 9:10 AM and loading on generator between 50% to 85% that ensure of running generator with no low and high of loading and ensure running generator with best efficiency of fuel consumption. When loading on 400 KVA generator exceeding 85% 500 KVA will run and loads will transformed to it automatically. Also as we see in below figure loading on 500 KVA will be between 50% to 85% .



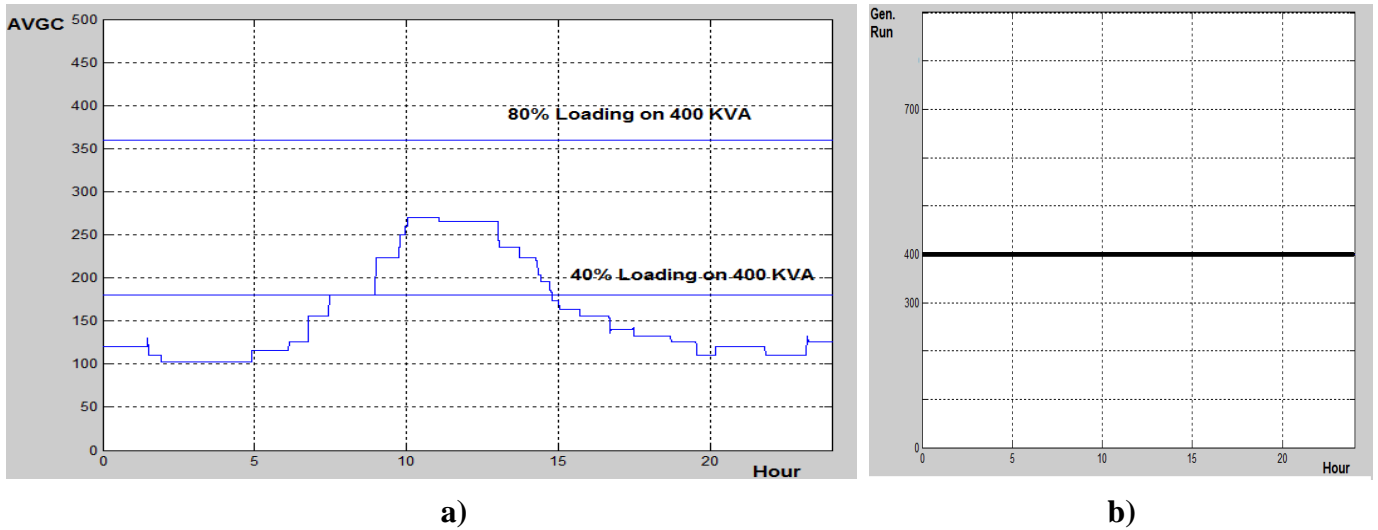
a)



b)

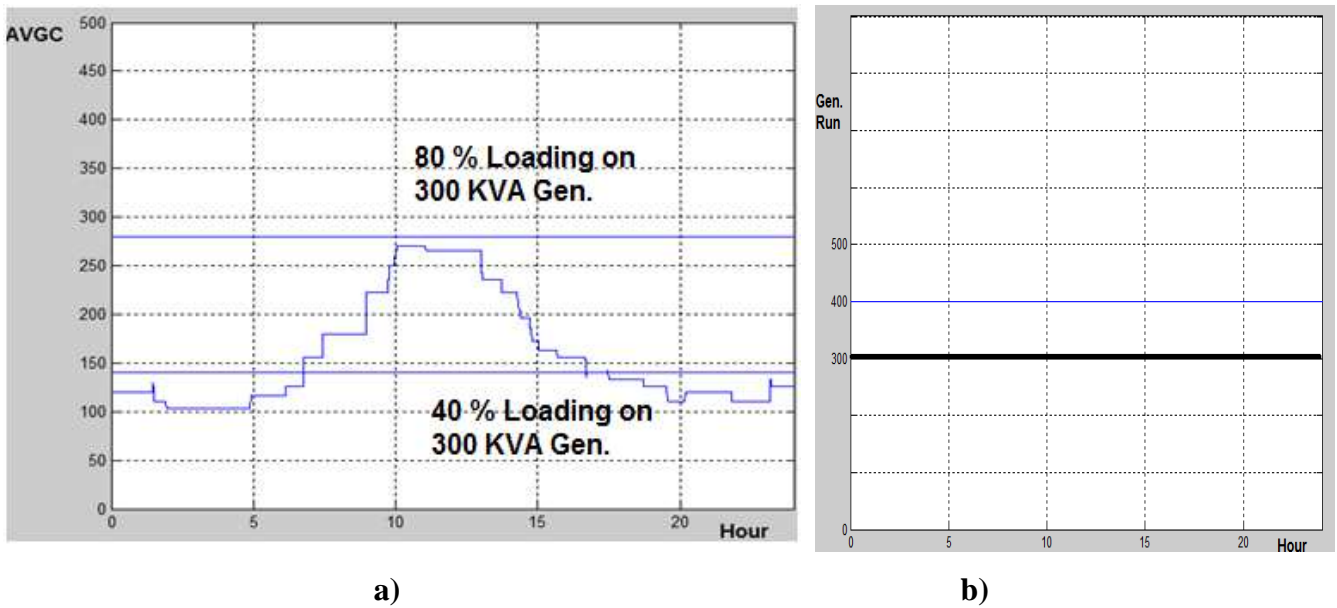
**Figure (4.6):** a) Hospital load curve in August for one day and, b) time period of running generators in suggested control system.

In April , In old electric power system as we see in figure (4.7) 400 KVA generator run for all day and it run in low load case for 17 hours.



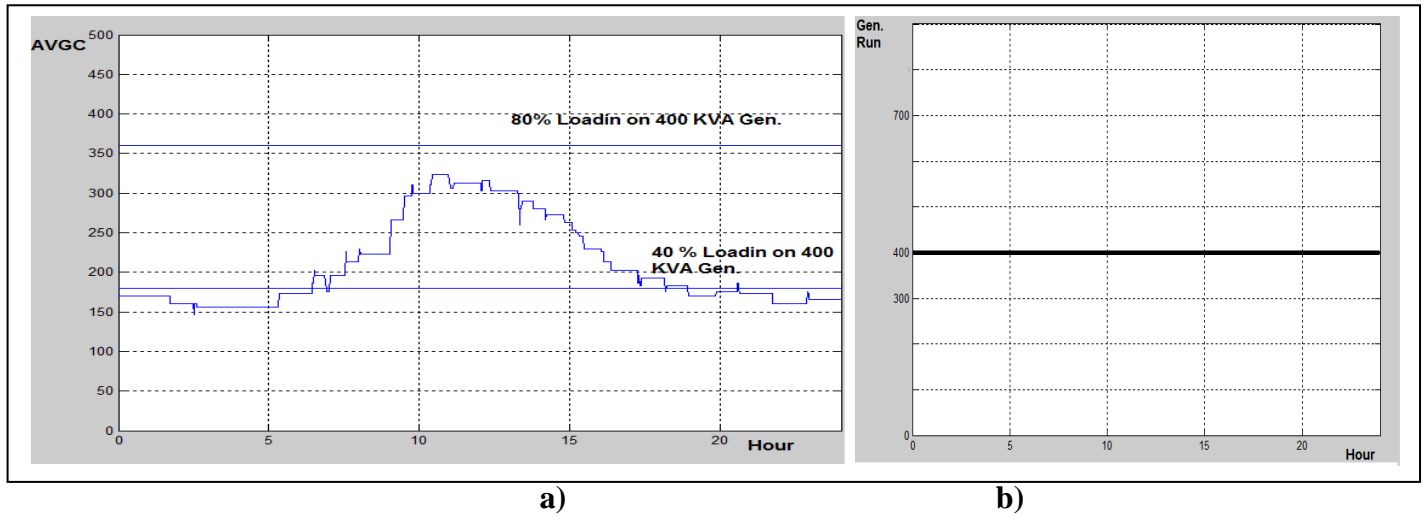
**Figure (4.7):** a) Hospital load curve in April for one day and, b) time period of running generators in old system.

As we see in our suggested approach in figure(4.8) 300 KVA generator running and supplying hospital loads (VIL and EL) and it run in low load case for 9 hours and we reducing running generators in low load case hours from 17 to 9 hours in April month.

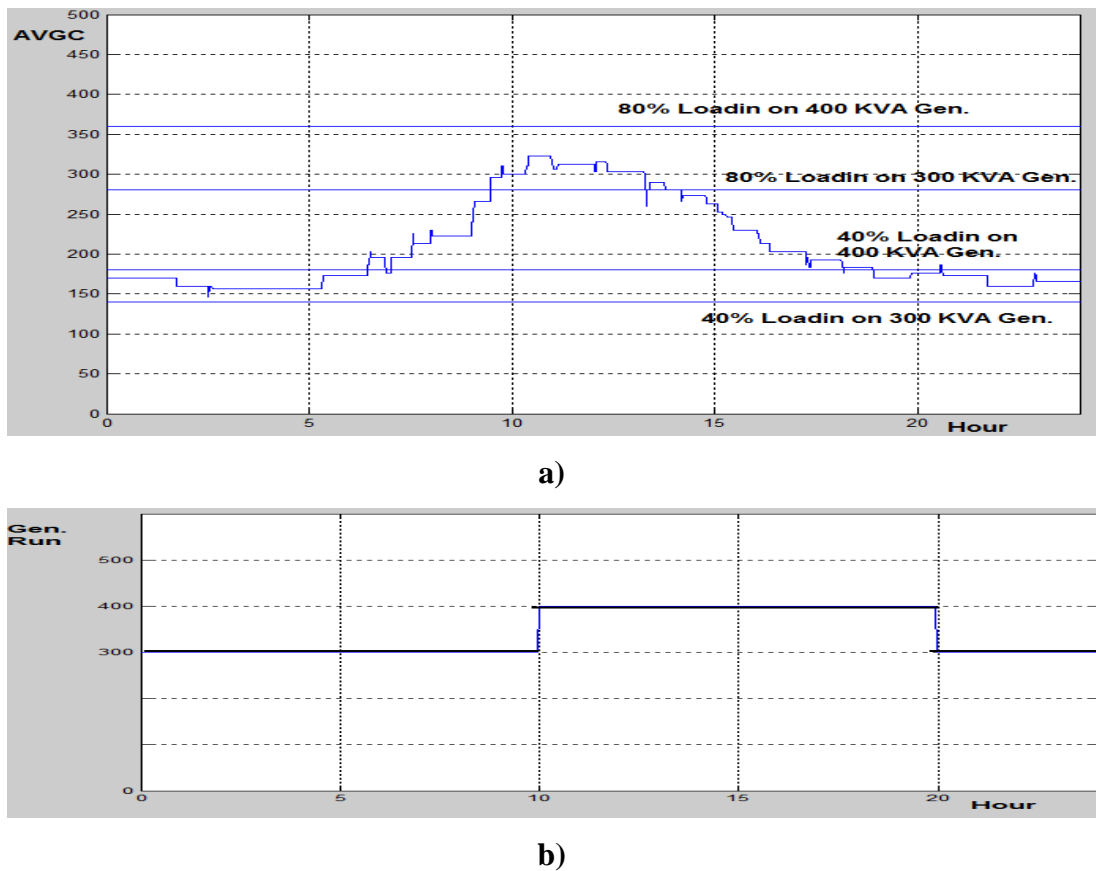


**Figure (4.8):** a) Hospital load curve in April for one day and, b) time period of running generators in suggested control system.

In September as we see in figure(4.9) when mains electrical source have been fault for all day the 400 KVA generator will run. 400 KVA will be in low load case for 12 hours.



**Figure (4.9):** a) Hospital load curve in September for one day and, b) time period of running generators in old system.



**Figure (4.10):** a) Hospital load curve in September for one day and, b) time period of running generators in suggested control system.

As see in previous figure 300 KVA generator starting in 12:00 Am to 10:00 Am when hospital loads exceeding 85% of generator rating capacity at 10:00 Am the system will automatically start 400 KVA and transfer loads to it. and then when loads drops to under 40% of 400 KVA generator rating capacity at 8:00 Pm the system will automatically start 300 KVA generator and transfer loads to it . As we see there is no low loading on generators.

When we looking in KAMAL EDWAN Hospital generators size we found 300 KVA and 400 KVA generators are suitable for hospital loads demand but 700 KVA generator is oversize for hospital load and if we running it for supplying makes it operating under low load case and thus reduces the generator life cycle and increasing fuel consumption .So we must replace 700 KVA generator with smaller one and I suggest replace it with 500 KVA like FGWilson P500-1 with prime capacity 455KVA(364KW) (FG Wilson,2014), where it appropriate in KAMAL EDWAN Hospital loads and it can run and supplying without any worry about low loading case.

## Chapter 5

### Conclusions

The purpose of this work is to find methods to reduce diesel fuel consumption in generators that operate by diesel engine and also to reduce generators maintenance due to low loading operation.

This thesis highlighted the electric power system located at Kamal Adwan Hospital as a case study. Main Electrical Distribution, manual, and automatic transferring switch boards were redesigned. Thus, the study also proposed resizing of the existing generators at Kamal Adwan hospital by replacing the largest generators by smaller one more suitable for loads in Kamal Adwan hospital. The control process in operation of generators and transfer loads from generator to another was implemented using a PLC to ensure the loading on the generator to be between 40% to 85% that satisfying best generator fuel consumption efficiency and avoiding generators operation in low loading case.

The proposed design empowers all generators to supply all hospital loads also contributes in reducing of the time period in which the generator works in low-load case; therefore, contributes in improvement of generator fuel consumption efficiency and increasing of the generators life. The proposed control system was simulated and tested on loads curve at three different days during the year and was compared with the existing system at Kamal Adwan hospital. We noticed that the number of generators low loading operation hours was decreased from 17 hours to 9 hours within one day in April and from 12 hours to zero within one day in September.

In future work, I would like to insert synchronizing running of two or three generators and loading together in our proposed system to avoid the needed huge size generators to meet future expansion.

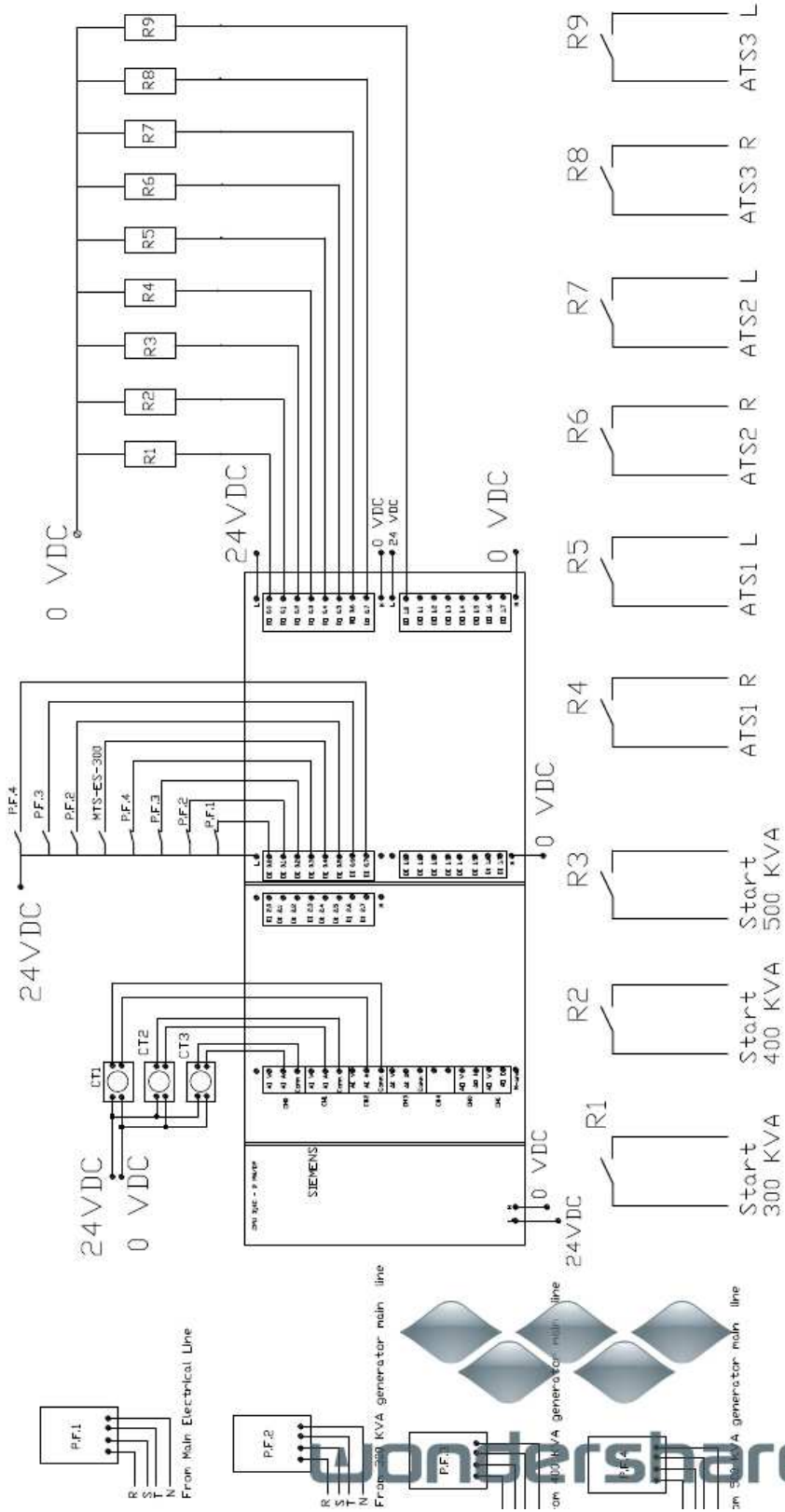
## References:

- Asato, B., Goya T., Uchida K., Yona A., & Senjyu T. (2010). "Optimal Operation of Smart Grid in Isolated Island". *IPEC Conference Proceedings*, 1100 – 1105.
- Bagen, Billinton R. ( 2005). "Evaluation of Different Operating Strategies in Small Stand-Alone Power Systems". *IEEE transactions on energy conversion*, 20(3), 654 - 660.
- Cummins Power Generation. (2007). *Generator set data sheet 706.3 KVA*. Retrieved in December, 20, 2015, from: [www.power.cummins.com](http://www.power.cummins.com)
- FG Wilson. (2014). *P300H-1*. Retrieved in December, 20, 2015, from: [www.FGWilson.com](http://www.FGWilson.com).
- FG Wilson. (2014). *P400-1*. Retrieved in December, 20, 2015, from: [www.FGWilson.com](http://www.FGWilson.com).
- FG Wilson. (2014). *P500-1*. Retrieved in December, 20, 2015, from: [www.FGWilson.com](http://www.FGWilson.com).
- Galande, G., Autade, P. (2015). "An embedded 1/3 phase automatic transfer switch with intelligent energy management". *International Journal of Computer Engineering and Applications*, IX( V), 9-14.
- Gaza Electricity Distribution Corporation. (2015). *Kamal Edwan Hospital electricity consumption Bills for year 2015*. Gaza.
- Guide to Best Energy Practices for Remote Facilities*. (1st ed.). (2011). Retrieved in December, 20, 2015, from: [www.aea.nt.ca](http://www.aea.nt.ca).
- Hesla, E., Parise, G., & Rifaat, M. (2006). "Comprehensive design of electrical installations by integrating system configuration and operational safety aspects". *Conference Record of the 2006 IEEE Industry Applications Conference Forty-First IAS Annual Meeting*, 5, 2631-2635.
- Hijjo, M. (2011). *Fuzzy Logic Based Solution to the Unit Commitment Problem* (Unpublished Master Thesis). Islamic University, Gaza.
- Kamal Edwan Hospital (Maintenance Department). (2015). *Daily register of operation hours number of generators and daily generators fuel consumption*, Gaza.
- Katiraei F., Abbey, C. (2007). "Diesel Plant Sizing and Performance Analysis of a Remote Wind-Diesel Microgrid". *Power Engineering Society General Meeting IEEE*, 1 – 8.

- Mizani, S., & Yazdani, A. (2009). "Design and Operation of a Remote Microgrid". *35th Annual Conference of IEEE on Industrial Electronics*, 4299 - 4304.
- Moshi, G., Pedico, M., Bovo, C., & Berizzi, A. (2014). "Optimal Generation Scheduling of Small Diesel Generators in a Microgrid". *IEEE International Energy Conference (ENERGYCON)*, 867 - 873.
- Palestinian Energy and Natural Resources Authority – PENRA. (2015). *Gaza needs of energy*. Retrieved in December, 20, 2015, from: [www.penra.gov.ps](http://www.penra.gov.ps)
- Parise, G., & Hesla, E. (2006). The sources sets for operational procedures. *IEEE Industrial and Commercial Power Systems Technical Conference*, 1 – 8.
- Parise, G., Hesla, E., & Parise, L. (2013). Transition theory in operation of electrical installations. *IEEE Transactions On Industry Applications*, 49(3), 1056 – 1061.
- Parise, G., Hesla, E., Parise, L., & Pennacchia, R. (2014). "Switching procedures in multiple source systems and the business continuity management: The flock logic of multi-set systems". *Industrial & Commercial Power Systems Technical Conference (I&CPS), IEEE/IAS 50<sup>th</sup>*, 1 – 6.
- Parise, G., Hesla, E., & Rifaat, R. (2009). "Architecture impact on integrity of electrical installations: Cut & tie rule, ring configuration, floating node". *IEEE Trans. Ind. Appl.*, 45(5), 1903–1909.
- Pushpavalli, M., Nivetha, K., & Dhanasu, M. (2015). "A new approach for an energy management system using ladder logic program for industry application". *International Journal of Advanced Research in Science, Engineering and Technology*, 2(4), 587-594.
- Tereshchenko, T., Pichkalov I., & Yamnenko, J. (2014). "Control of Fuel Consumption as an Aspect of Resource Saving in Hybrid Uninterruptible Power Systems". *55th International Scientific Conference on Power and Electrical Engineering*, 255 – 258.
- Tufte, D. (2014). *Impacts of Low Load Operation of Modern Four-Stroke Diesel Engines in Generator Configuration* (Unpublished Master Thesis). Norwegian University of Science and Technology, Norway.

# Appendix A

## PLC Wiring Diagram





Where:

**Siemens CPU 314C-2PN/DP:** PLC with 24 digital inputs, 16 digital outputs, 5 analog input , 2 analog output . the PLC supplied with 24 v DC .

**P.F.1:** phase frailer detection contains one normally open contact and one normally close contact where its function is to detect if there is a fault (phase or neutral lost , wrong in phases sequence )in Maine electrical supply or not.

**P.F.2:** have same function as P.F.1 but detect if there is a fault in 300 KVA generator electrical line .

**P.F.3:** have same function as P.F.1 but detect if there is a fault in 400 KVA generator electrical line .

**P.F.4:** have same function as P.F.1 but detect if there is a fault in 500 KVA generator electrical line .

**C.T.1, C.T.2, and C.T.3:** current transformers installed in the output of MTS1 bus bar lines to measures current flow supplied to ESL and VIL . this C.T.s supplied with 24 v DC and send 4 to 20 mA analog signal to PLC . analog signal transmitted by C.T.s refers to current flow through CTs varies from 0 to 1000 A .

**MTS-ES-300:** normally open auxiliary built in MTS4 notify the PLC that 300 KVA generator can supply ESL .

**R1:** 24 v DC relay activated by PLC, used to send signal to 300 KVA generator to run

**R2:** 24 v DC relay activated by PLC, used to send signal to 400 KVA generator to run

**R3:** 24 v DC relay activated by PLC, used to send signal to 500 KVA generator to run

**R4:** 24 v DC relay activated by PLC , used to send signal to ATS1 to switch ATS1 to connect loads with engine electrical power generators (400 KVA or 500 KVA)

**R5:** 24 v DC relay activated by PLC , used to send signal to ATS1 to switch ATS1 to connect loads with main electrical supply grid .

**R6:** 24 v DC relay activated by PLC , used to send signal to ATS2 to switch ATS2 to connect loads with 400 KVA generator.

**R7:** 24 v DC relay activated by PLC , used to send signal to ATS2 to switch ATS2 to connect loads with 500 KVA generator.

**R8:** 24 v DC relay activated by PLC , used to send signal to ATS3 to switch ATS3 to connect loads with 300 KVA generator.

**R9:** 24 v DC relay activated by PLC , used to send signal to ATS3 to switch ATS3 to connect loads with one of rest of three main sources(main grid , 400 KVA generator ,or 500 KVA generator) .

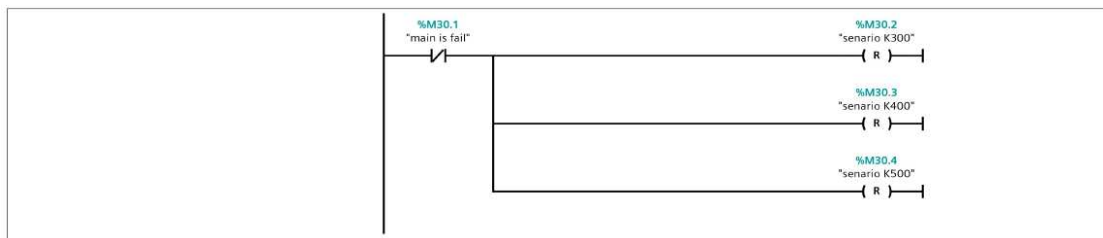
# Appendix B

## PLC Ladder Program

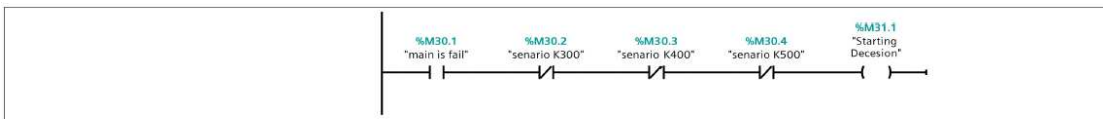
**Network 1: monitoring main supply**



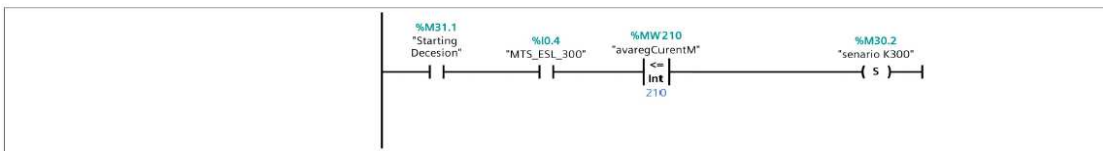
**Network 2: main not not not not fail**



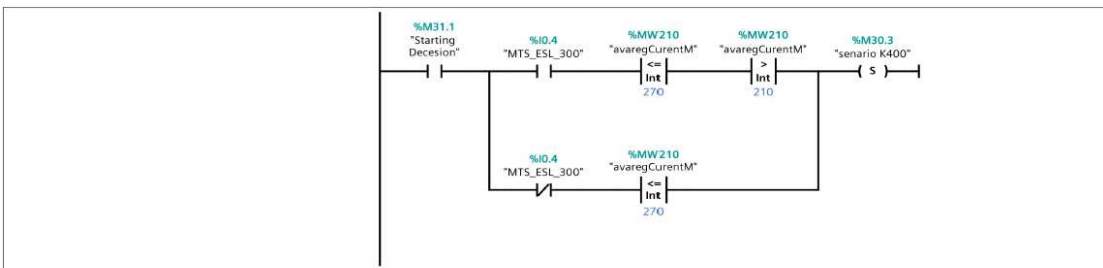
**Network 3: starting decesion when all generators are OK**



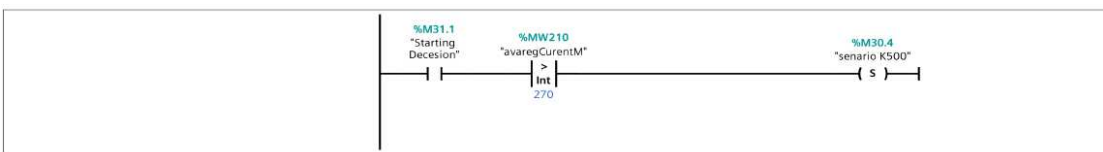
**Network 4: select K300**



**Network 5: select K400**



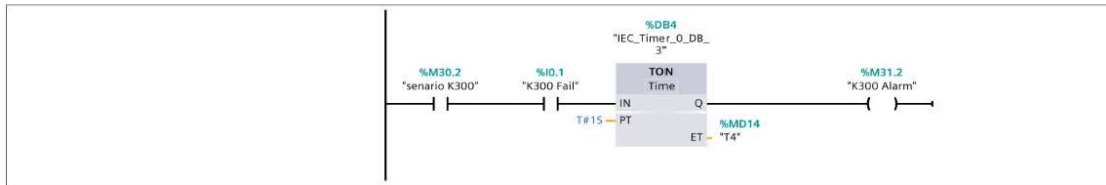
**Network 6: select K500**



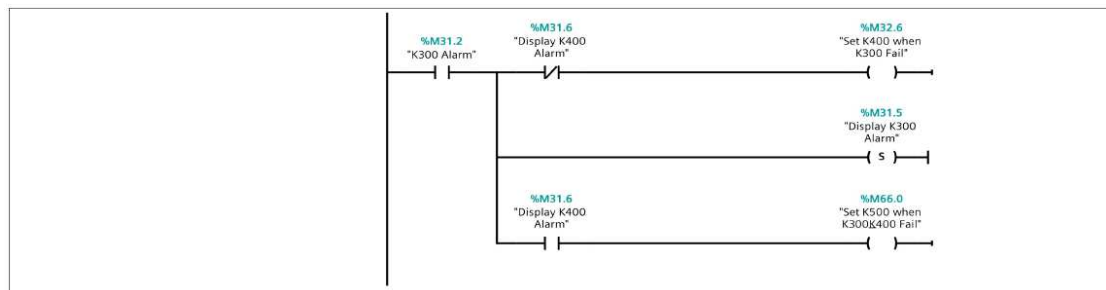
Network 8: senario K300



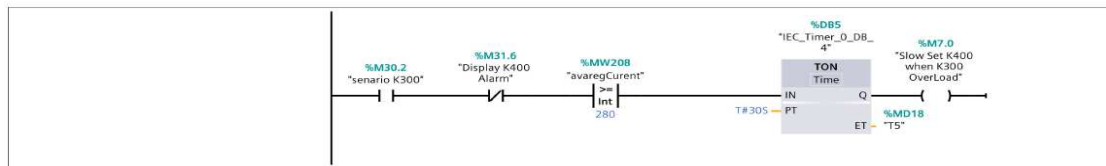
Network 9: K300 alarm



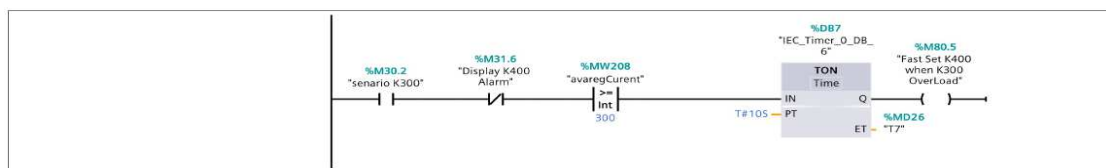
Network 10: K300 alarm



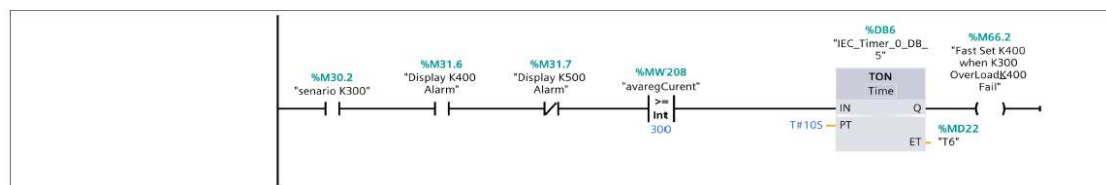
Network 11: slow transition from senario K300 to K400



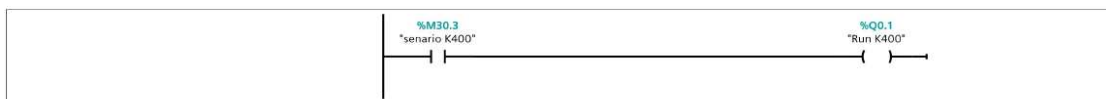
Network 12: fast transition from senario K300 to K400



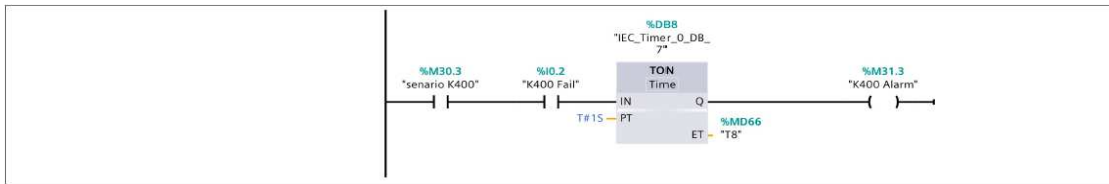
Network 13: fast transition from senario K300 to K500 when k400 fault



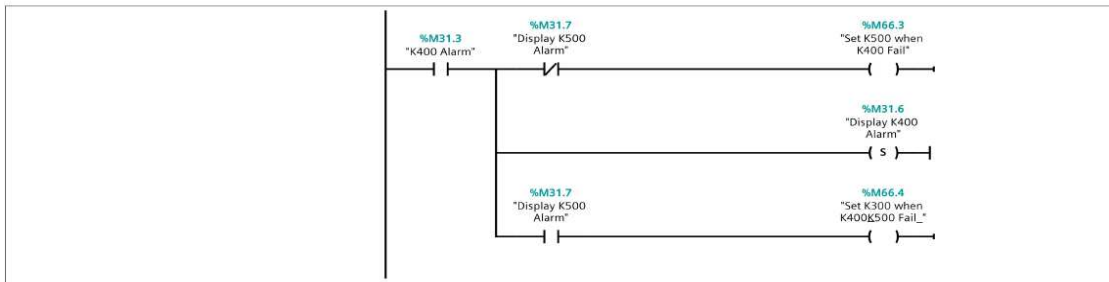
Network 15: senario K400



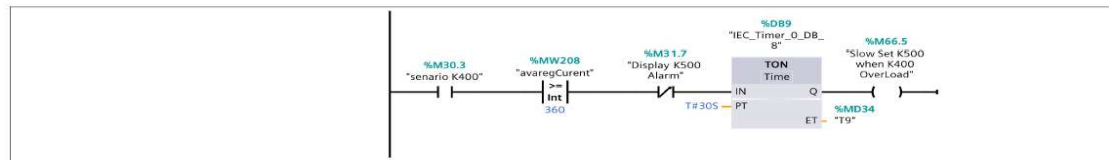
Network 16: k400 fail



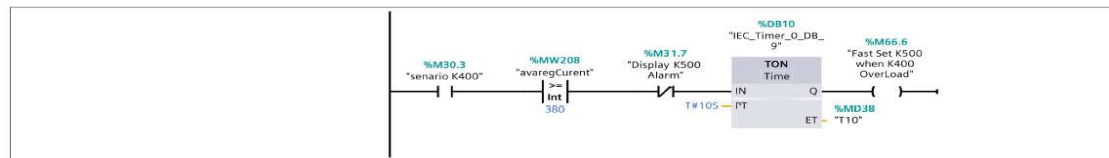
Network 17: k400 fail



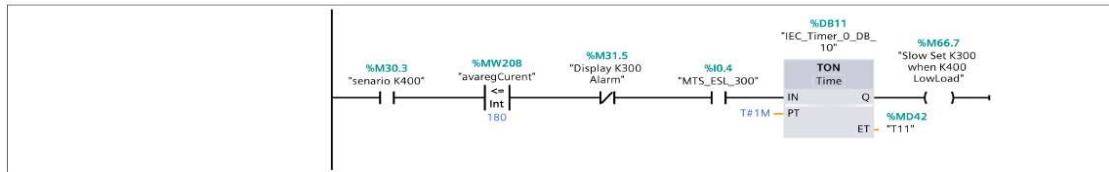
Network 18: slow transition from senario K400 to K500



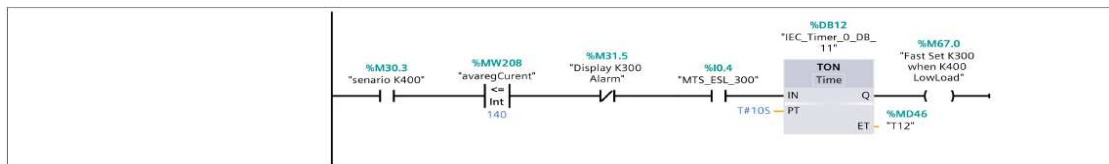
Network 19: fast transition from senario K400 to K500



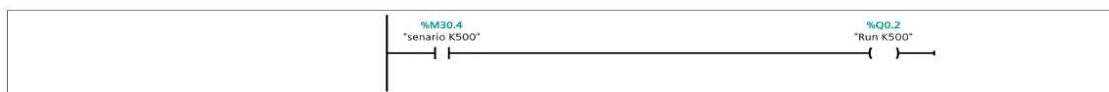
Network 20: slow transition from senario K400 to K300



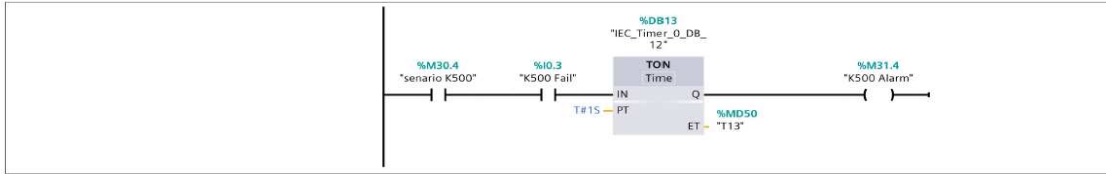
Network 21: fast transition from senario K400 to K300



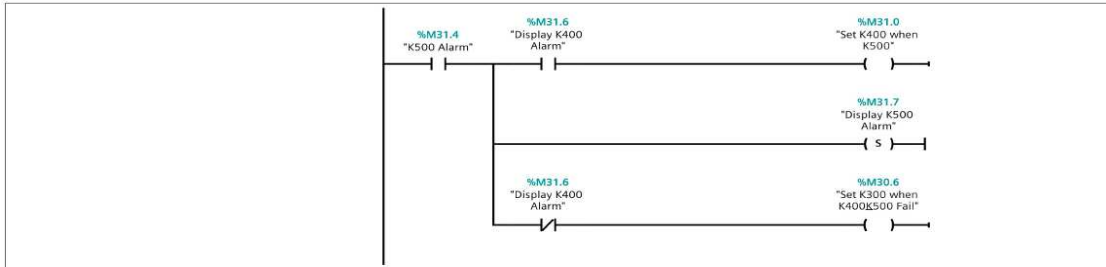
Network 23: senario k500



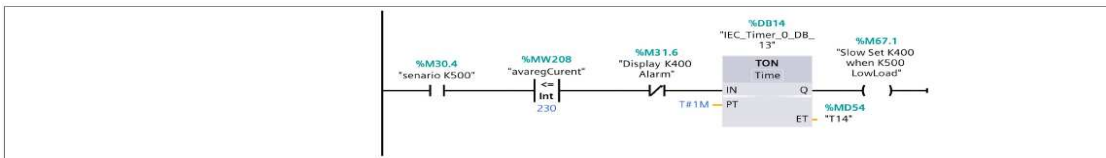
Network 24: k500 alarm



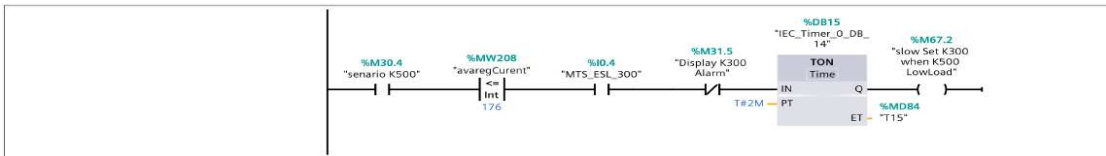
Network 25: k500 alarm



Network 26: slow transition from senario K500 to K400



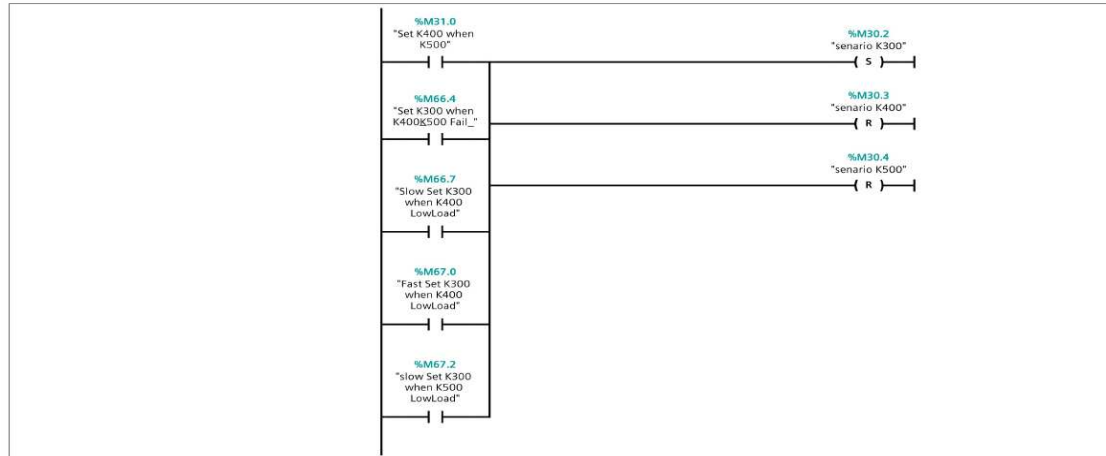
Network 27: slow transition from senario K500 to K300



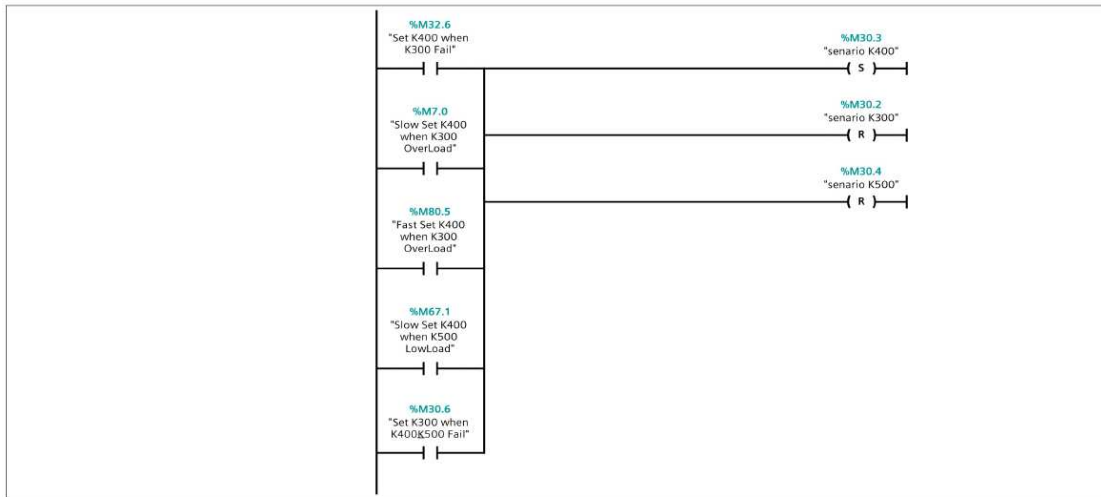
Network 28:



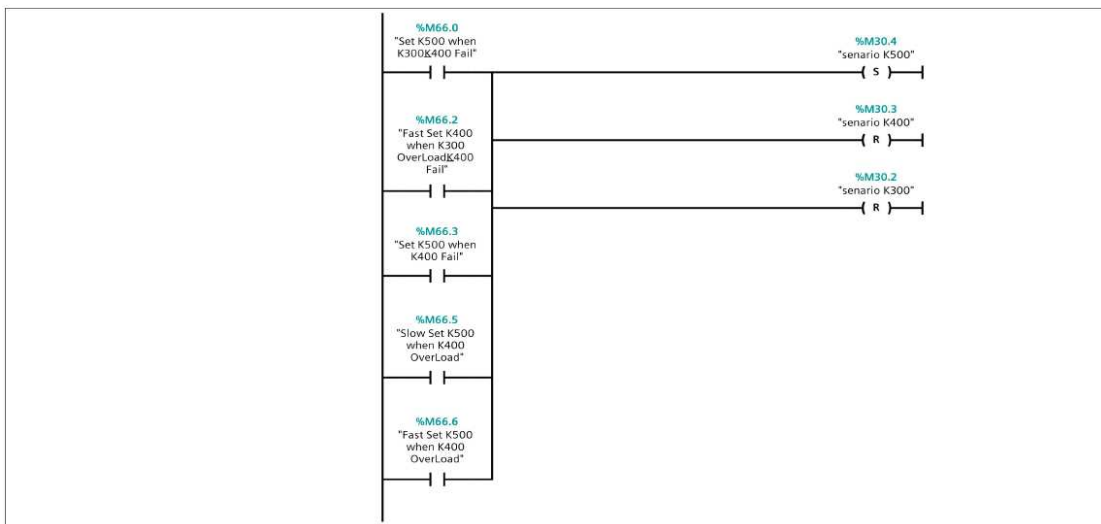
Network 29: set senario k300



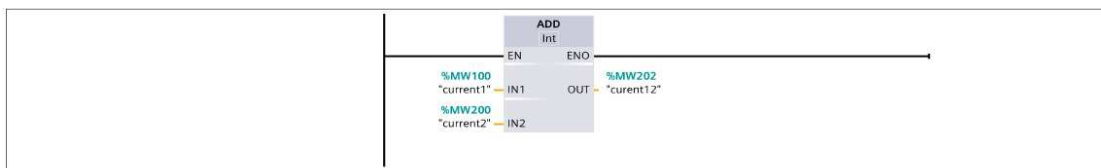
Network 30: set senario k400



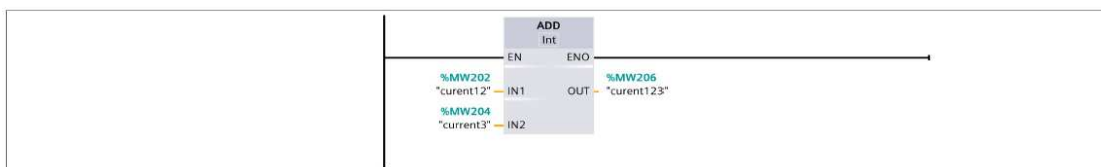
Network 31: set senario k500



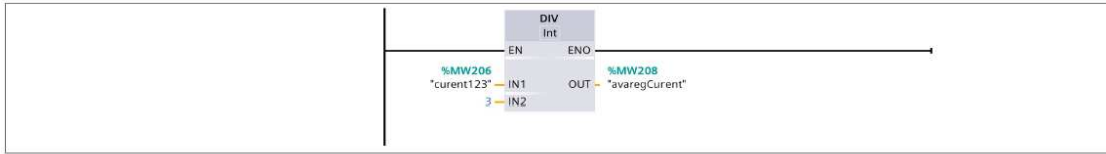
Network 33: current mesuring c1 added to c2



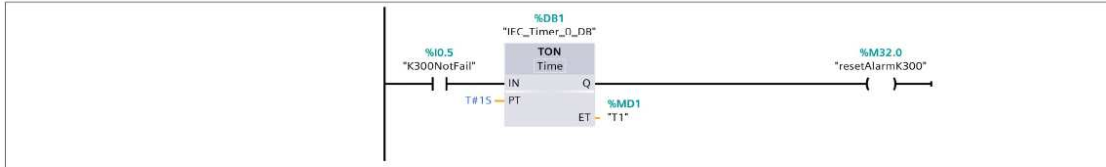
Network 34: current mesuring c12 added to c3



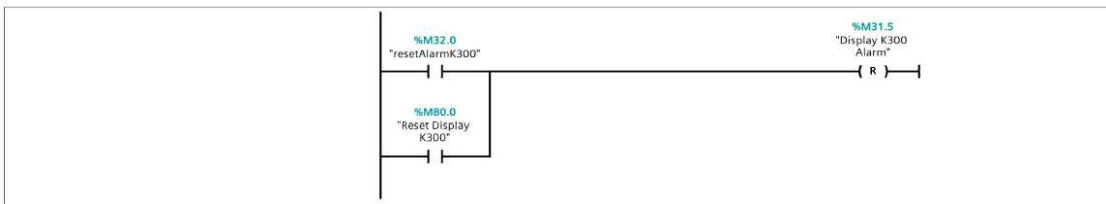
Network 35: current mesuring AVAREG CURRENT



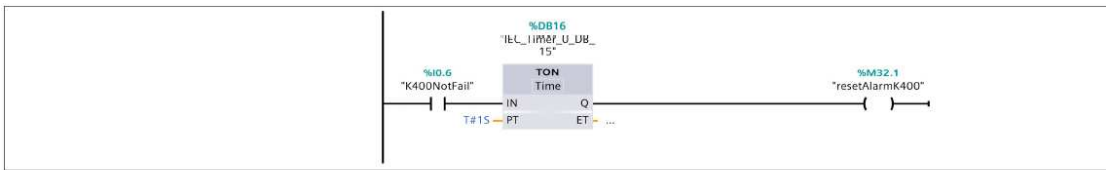
Network 37: Automatic Reset Alarm K300



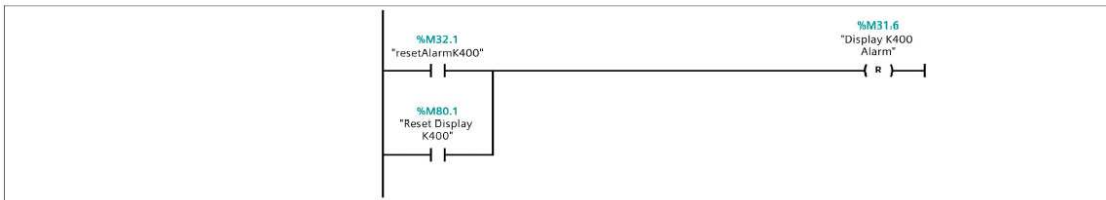
Network 38: Automatic Reset Alarm K300



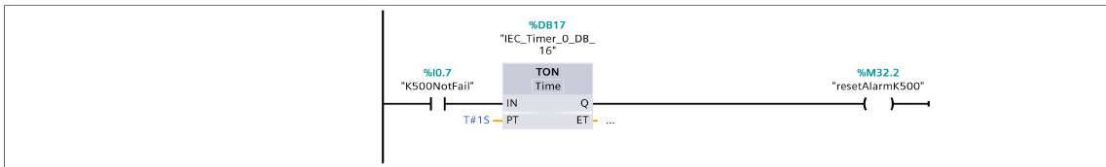
Network 39: Automatic Reset Alarm K400



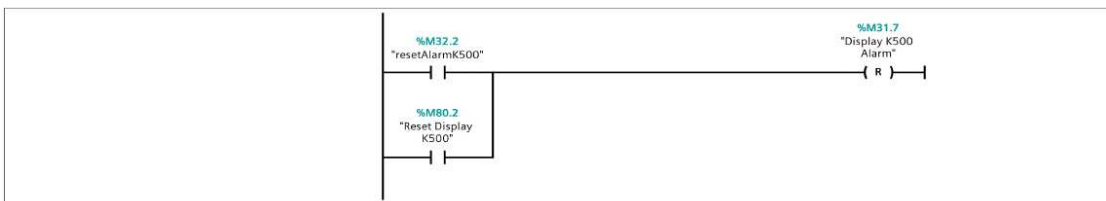
Network 40: Automatic Reset Alarm K400



Network 41: Automatic Reset Alarm K500

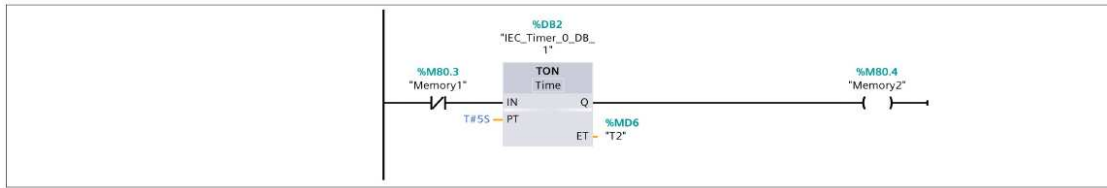


Network 42: Automatic Reset Alarm K500

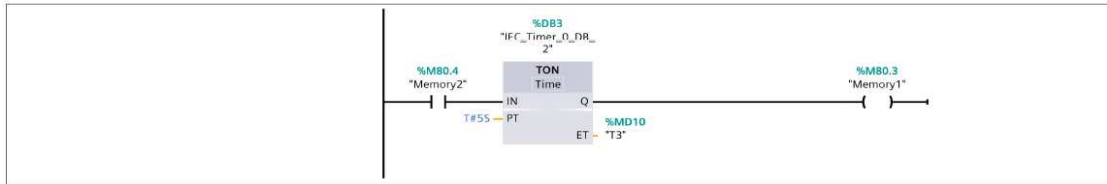


Network 43: Memory

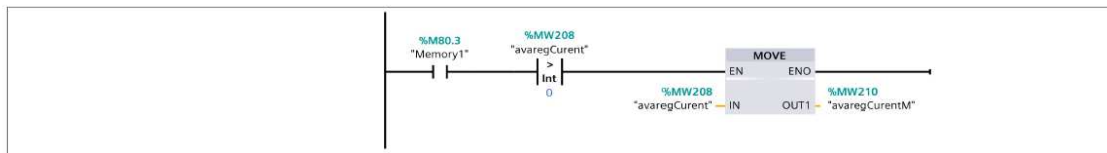




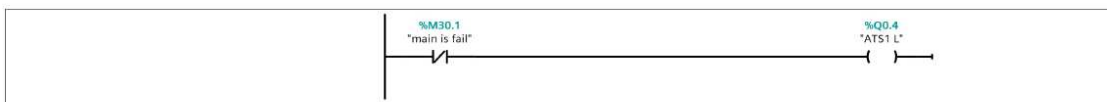
Network 44: Memory



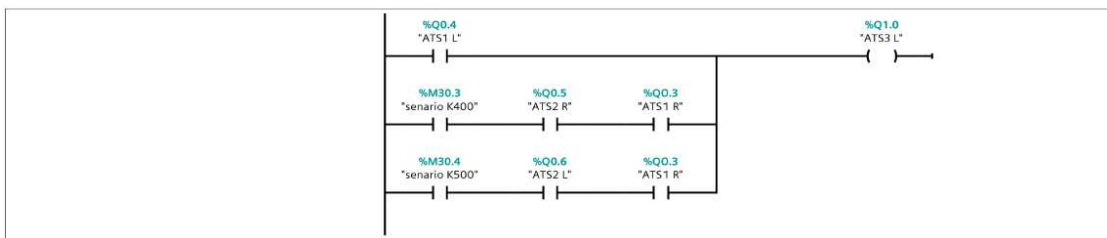
Network 45: Memory



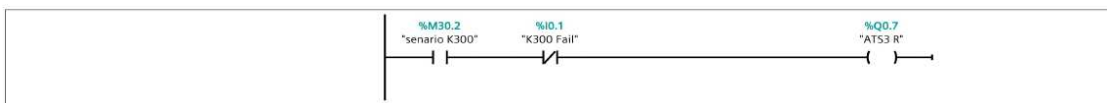
Network 47: ATS1 left



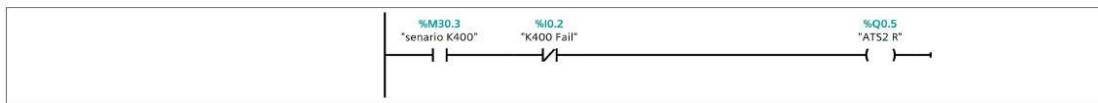
Network 48: ATS3 Left



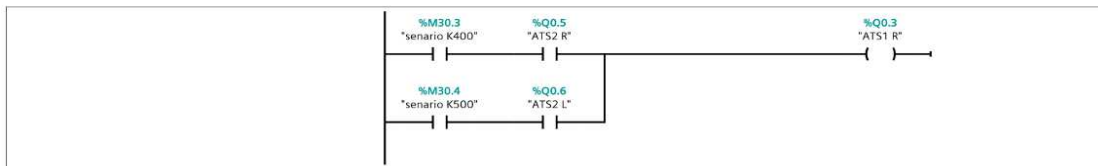
Network 49: ATS3 Right



**Network 50: ATS2 Right**



**Network 51: ATS1 Right**



**Network 52: ATS2 Left**

